



LED Street Lights in Alaska

Final Report

Alaska University Transportation Center

Prepared By:
Richard Wies
Dalton Ellingson
Michael Elbert

September 2010

Prepared By:

Alaska University Transportation Center
Duckering Building Room 245
P.O. Box 755900
Fairbanks, AK 99775-5900

INE # 12.11

REPORT DOCUMENTATION PAGE

Form approved OMB No.

Public reporting for this collection of information is estimated to average 1 hour per response, including the time for reviewing instructions, searching existing data sources, gathering and maintaining the data needed, and completing and reviewing the collection of information. Send comments regarding this burden estimate or any other aspect of this collection of information, including suggestion for reducing this burden to Washington Headquarters Services, Directorate for Information Operations and Reports, 1215 Jefferson Davis Highway, Suite 1204, Arlington, VA 22202-4302, and to the Office of Management and Budget, Paperwork Reduction Project (0704-1833), Washington, DC 20503

1. AGENCY USE ONLY (LEAVE BLANK)		2. REPORT DATE September 2010	3. REPORT TYPE AND DATES COVERED Final Report (9/1/2008-09/1/2010)	
4. TITLE AND SUBTITLE LED Street Lights in Alaksa			5. FUNDING NUMBERS AUTC# 207099 DTRT06-G0011	
6. AUTHOR(S) Richard Wies, Dalton Ellingson, Michael Ebert				
7. PERFORMING ORGANIZATION NAME(S) AND ADDRESS(ES) Alaska University Transportation Center P.O. Box 755900 Fairbanks, AK 99775-5900			8. PERFORMING ORGANIZATION REPORT NUMBER INE/AUTC 12.11	
9. SPONSORING/MONITORING AGENCY NAME(S) AND ADDRESS(ES)			10. SPONSORING/MONITORING AGENCY REPORT NUMBER	
11. SUPPLEMENTARY NOTES				
12a. DISTRIBUTION / AVAILABILITY STATEMENT No restrictions			12b. DISTRIBUTION CODE	
13. ABSTRACT (Maximum 200 words) During winter nights in Alaska, streetlights often remain lit more than half the day, using energy all the while. Around the nation, communities are exploring the use of light-emitting diode technology for lighting streets and reducing energy use. Already, LED technology is successfully used in flashlights and electronic billboards. Some researchers suggest that, under ideal conditions, an LED streetlight system might use 50% to 75% less energy than a traditional streetlight system, with a longer performance life, too. In general, LED devices tend to be less fragile, switching on and off quickly, without flickering. LED technology, which may be the next step in efficient indoor lighting after fluorescents, is moving into the municipal streetlight market as a possible alternative to high-pressure sodium lamps. For this reason, AUTC researchers at UAA are exploring the use of LED streetlight technology for the Municipality of Anchorage.				
14. KEYWORDS: Lighting, Luminaires, Street Lighting			15. NUMBER OF PAGES 119	
			16. PRICE CODE N/A	
17. SECURITY CLASSIFICATION OF REPORT Unclassified	18. SECURITY CLASSIFICATION OF THIS PAGE Unclassified	19. SECURITY CLASSIFICATION OF ABSTRACT Unclassified	20. LIMITATION OF ABSTRACT N/A	

Notice

This document is disseminated under the sponsorship of the U.S. Department of Transportation in the interest of information exchange. The U.S. Government assumes no liability for the use of the information contained in this document.

The U.S. Government does not endorse products or manufacturers. Trademarks or manufacturers' names appear in this report only because they are considered essential to the objective of the document.

Quality Assurance Statement

The Federal Highway Administration (FHWA) provides high-quality information to serve Government, industry, and the public in a manner that promotes public understanding. Standards and policies are used to ensure and maximize the quality, objectivity, utility, and integrity of its information. FHWA periodically reviews quality issues and adjusts its programs and processes to ensure continuous quality improvement.

Author's Disclaimer

Opinions and conclusions expressed or implied in the report are those of the author. They are not necessarily those of the Alaska DOT&PF or funding agencies.

SI* (MODERN METRIC) CONVERSION FACTORS

APPROXIMATE CONVERSIONS TO SI UNITS

Symbol	When You Know	Multiply By	To Find	Symbol
LENGTH				
in	inches	25.4	millimeters	mm
ft	feet	0.305	meters	m
yd	yards	0.914	meters	m
mi	miles	1.61	kilometers	km
AREA				
in ²	square inches	645.2	square millimeters	mm ²
ft ²	square feet	0.093	square meters	m ²
yd ²	square yard	0.836	square meters	m ²
ac	acres	0.405	hectares	ha
mi ²	square miles	2.59	square kilometers	km ²
VOLUME				
fl oz	fluid ounces	29.57	milliliters	mL
gal	gallons	3.785	liters	L
ft ³	cubic feet	0.028	cubic meters	m ³
yd ³	cubic yards	0.765	cubic meters	m ³
NOTE: volumes greater than 1000 L shall be shown in m ³				
MASS				
oz	ounces	28.35	grams	g
lb	pounds	0.454	kilograms	kg
T	short tons (2000 lb)	0.907	megagrams (or "metric ton")	Mg (or "t")
TEMPERATURE (exact degrees)				
°F	Fahrenheit	5 (F-32)/9 or (F-32)/1.8	Celsius	°C
ILLUMINATION				
fc	foot-candles	10.76	lux	lx
fl	foot-Lamberts	3.426	candela/m ²	cd/m ²
FORCE and PRESSURE or STRESS				
lbf	poundforce	4.45	newtons	N
lbf/in ²	poundforce per square inch	6.89	kilopascals	kPa
APPROXIMATE CONVERSIONS FROM SI UNITS				
Symbol	When You Know	Multiply By	To Find	Symbol
LENGTH				
mm	millimeters	0.039	inches	in
m	meters	3.28	feet	ft
m	meters	1.09	yards	yd
km	kilometers	0.621	miles	mi
AREA				
mm ²	square millimeters	0.0016	square inches	in ²
m ²	square meters	10.764	square feet	ft ²
m ²	square meters	1.195	square yards	yd ²
ha	hectares	2.47	acres	ac
km ²	square kilometers	0.386	square miles	mi ²
VOLUME				
mL	milliliters	0.034	fluid ounces	fl oz
L	liters	0.264	gallons	gal
m ³	cubic meters	35.314	cubic feet	ft ³
m ³	cubic meters	1.307	cubic yards	yd ³
MASS				
g	grams	0.035	ounces	oz
kg	kilograms	2.202	pounds	lb
Mg (or "t")	megagrams (or "metric ton")	1.103	short tons (2000 lb)	T
TEMPERATURE (exact degrees)				
°C	Celsius	1.8C+32	Fahrenheit	°F
ILLUMINATION				
lx	lux	0.0929	foot-candles	fc
cd/m ²	candela/m ²	0.2919	foot-Lamberts	fl
FORCE and PRESSURE or STRESS				
N	newtons	0.225	poundforce	lbf
kPa	kilopascals	0.145	poundforce per square inch	lbf/in ²

*SI is the symbol for the International System of Units. Appropriate rounding should be made to comply with Section 4 of ASTM E380.
(Revised March 2003)

Table of Contents

Table of Contents	ii
List of Figures	iv
List of Tables	vii
Acknowledgements	viii
Abstract	ix
Summary of Findings	x
CHAPTER 1 - INTRODUCTION AND RESEARCH APPROACH	1
Problem Statement and Research Objective	1
Scope of Study	1
Research Approach	3
Street Light Illuminance, Power Consumption, and Spectrum Measurement Setup	4
CHAPTER 2 - FINDINGS	7
LED and HPS Street Light Testing Results	7
Photopic Illuminance and Power Consumption Results	7
Light Spectrum Results	8
Overall Analysis	9
Photopic Illuminance Analysis	9
Power Consumption Analysis	11
Light Spectrum Analysis	11
CHAPTER 3 - INTERPRETATION, APPRAISAL, AND APPLICATIONS	13
General Recommendations	13
AASHTO Standards	13
Power Consumption and Energy Savings Potential	14
Color Spectrum	15
CHAPTER 4 - CONCLUSIONS AND SUGGESTED RESEARCH	16
Conclusions	16
Suggested Research	17
REFERENCES	18
APPENDIX A: AASHTO Roadway Lighting Design Illuminance Values; Street Lights, Light Meter, Power Meter, and Spectroradiometer Specification and Data Sheets	19

AASHTO Roadway Lighting Design Guide, Table 3-5a: Illuminance and Luminance Design Values (English).....	20
Beta 40 LED (BXSL03034B-UR) and Beta 60 LED (BXSL03051B-VR).....	21
Street Light Specification/Data Sheets	21
Everlight Americas Dolphin 90 (SL-Dolphin/100240AC/PH90B) and	23
Dolphin 120 (SL-Dolphin/100240AC/PH120B) Street Light Specification/Data Sheets	23
American Electric Lighting 115 HPS (115-15-S-MR-240-R2-FG-DF-HP-UL).....	34
Street Light Specification/Data Sheets	34
General Electric M-400A HPS (MDCL-25-S-3-A-1-2-F-MC3-2-FU) Street Light Specification/Data Sheets	37
Extech HD450 Light Meter Product Data Sheets	39
Fluke 43B Power Quality Analyzer Specification/Data Sheet	40
Apogee PS-300 Spectroradiometer Specification/Data Sheets.....	44
APPENDIX B: Tables I-X of a) Measured Illuminance at Floor Level b) Electrical Parameters, and c) Measured Illuminance Levels at 2, 4, and 6 Foot Heights on Measurement Grid.....	46
APPENDIX C: Contour and Surface Plots of Measured and Height Adjusted Illuminance on Measurement Grid	67
Figures 3-12: Contour Plots of Isoilluminance (fc) at Floor Level (0 feet) on Measurement Grid with Light at 10 Feet Height.....	68
Figures 13-22: Surface Plots of Illuminance (fc) at a) 0, b) 2, c) 4 and d) 6 Feet Heights on Measurement Grid	78
Figures 23-32: Contour Plots of Isoilluminance (fc) at Floor Level on Measurement Grid for a) 20 Feet and b) 30 Feet Mounting Height.....	88
APPENDIX D: Figures 33-39: Light Spectrum at a) 0 and b) 6 Feet Heights at the Center of Light.....	98

List of Figures

Figure 1: Normalized photopic (black) and scotopic (green) light spectrums. [5] The photopic light spectrum includes the CIE 1931 standard [6] (solid), the Judd-Vos 1978 modified data [7-9] (dashed), and the Sharpe, Stockman, Jagla & Jägle 2005 data [10] (dotted). (Adapted from [5]).....	4
Figure 2: Street Light Illuminance Measurement Grid.....	5
Figure 3: Contour Plot of Isoilluminance (fc) for Beta 40 LED Low Driver Setting at the Floor (0 Feet) Level on Measurement Grid.....	68
Figure 4: Contour Plot of Isoilluminance (fc) for Beta 40 LED Mid Driver Setting at the Floor (0 Feet) Level on Measurement Grid.....	69
Figure 5: Contour Plot of Isoilluminance (fc) for Beta 40 LED High Driver Setting at the Floor (0 Feet) Level on Measurement Grid.....	70
Figure 6: Contour Plot of Isoilluminance (fc) for Beta 60 LED Low Driver Setting at the Floor (0 Feet) Level on Measurement Grid.....	71
Figure 7: Contour Plot of Isoilluminance (fc) for Beta 60 LED Mid Driver Setting at the Floor (0 Feet) Level on Measurement Grid.....	72
Figure 8: Contour Plot of Isoilluminance (fc) for Beta 60 LED High Driver Setting at the Floor (0 Feet) Level on Measurement Grid.....	73
Figure 9: Contour Plot of Isoilluminance (fc) for Dolphin 90 LED at the Floor (0 Feet) Level on Measurement Grid.....	74
Figure 10: Contour Plot of Isoilluminance (fc) for Dolphin 120 LED at the Floor (0 Feet) Level on Measurement Grid.....	75
Figure 11: Contour Plot of Isoilluminance (fc) for HPS 150 at the Floor (0 Feet) Level on Measurement Grid.....	76
Figure 12: Contour Plot of Isoilluminance (fc) for HPS 250 at the Floor (0 Feet) Level on Measurement Grid.....	77
Figure 13: Surface Plots of Illuminance (fc) for Beta 40 LED Low Driver Setting at a) 0, b) 2, c) 4 and d) 6 Feet Heights on Measurement Grid.....	78
Figure 14: Surface Plots of Illuminance (fc) for Beta 40 LED Mid Driver Setting at a) 0, b) 2, c) 4 and d) 6 Feet Heights on Measurement Grid.....	79
Figure 15: Surface Plots of Illuminance (fc) for Beta 40 LED High Driver Setting at a) 0, b) 2, c) 4 and d) 6 Feet Heights on Measurement Grid.....	80
Figure 16: Surface Plots of Illuminance (fc) for Beta 60 LED Low Driver Setting at a) 0, b) 2, c) 4 and d) 6 Feet Heights on Measurement Grid.....	81
Figure 17: Surface Plots of Illuminance (fc) for Beta 60 LED Mid Driver Setting at a) 0, b) 2, c) 4 and d) 6 Feet Heights on Measurement Grid.....	82
Figure 18: Surface Plots of Illuminance (fc) for Beta 60 LED High Driver Setting at a) 0, b) 2, c) 4 and d) 6 Feet Heights on Measurement Grid.....	83

Figure 19: Surface Plots of Illuminance (fc) for Dolphin 90 LED at a) 0, b) 2, c) 4 and d) 6 Feet Heights on Measurement Grid	84
Figure 20: Surface Plots of Illuminance (fc) for Dolphin 120 LED at a) 0, b) 2, c) 4 and d) 6 Feet Heights on Measurement Grid	85
Figure 21: Surface Plots of Illuminance (fc) for HPS 150 at a) 0, b) 2, c) 4 and d) 6 Feet Heights on Measurement Grid	86
Figure 22: Surface Plots of Illuminance (fc) for HPS 250 at a) 0, b) 2, c) 4 and d) 6 Feet Heights on Measurement Grid	87
Figure 23: Contour Plots of Isoilluminance (fc) for Beta 40 LED Low Driver Setting at Floor Level (0 feet) on Measurement Grid with Light at a) 20 Feet and b) 30 Feet Height	88
Figure 24: Contour Plots of Isoilluminance (fc) for Beta 40 LED Mid Driver Setting at Floor Level (0 feet) on Measurement Grid with Light at a) 20 Feet and b) 30 Feet Height	89
Figure 25: Contour Plots of Isoilluminance (fc) for Beta 40 LED High Driver Setting at Floor Level (0 feet) on Measurement Grid with Light at a) 20 Feet and b) 30 Feet Height	90
Figure 26: Contour Plots of Isoilluminance (fc) for Beta 60 LED Low Driver Setting at Floor Level (0 feet) on Measurement Grid with Light at a) 20 Feet and b) 30 Feet Height	91
Figure 27: Contour Plots of Isoilluminance (fc) for Beta 60 LED Mid Driver Setting at Floor Level (0 feet) on Measurement Grid with Light at a) 20 Feet and b) 30 Feet Height	92
Figure 28: Contour Plots of Isoilluminance (fc) for Beta 60 LED High Driver Setting at Floor Level (0 feet) on Measurement Grid with Light at a) 20 Feet and b) 30 Feet Height	93
Figure 29: Contour Plots of Isoilluminance (fc) for Dolphin 90 LED at Floor Level (0 feet) on Measurement Grid with Light at a) 20 Feet and b) 30 Feet Height.....	94
Figure 30: Contour Plots of Isoilluminance (fc) for Dolphin 120 LED at Floor Level (0 feet) on Measurement Grid with Light at a) 20 Feet and b) 30 Feet Height.....	95
Figure 31: Contour Plots of Isoilluminance (fc) for HPS 150 at Floor Level (0 feet) on Measurement Grid with Light at a) 20 Feet and b) 30 Feet Height.....	96
Figure 32: Contour Plots of Isoilluminance (fc) for HPS 250 at Floor Level (0 feet) on Measurement Grid with Light at a) 20 Feet and b) 30 Feet Height.....	97
Figure 33: Stray Light Spectrum at a) 0 and b) 6 Feet Heights at the Center of Light.....	99
Figure 34: Light Spectrum for Beta 40 LED on a) Low, b) Medium, and c) High Driver Setting at 6 Feet Height at the Center of Light	100
Figure 35: Light Spectrum for Beta 60 LED on a) Low, b) Medium, and c) High Driver Setting at 6 Feet Height at the Center of Light	101
Figure 36: Light Spectrum for a) Dolphin 90 and b) Dolphin 120 at 6 Feet Height at the Center of Light.....	102
Figure 37: Light Spectrum for a) HPS 150 and b) HPS 250 at Floor Level (0 Feet) at the Center of Light.....	103

Figure 38: Stray Light Spectrum (including near Infrared) at Floor Level (0 Feet) at the Center of Light..... 104

Figure 39: Light Spectrum (including near Infrared) for a) HPS 150 and b) HPS 250 at Floor Level (0 Feet) at the Center of Light 105

List of Tables

Table I: Average Illuminance on Two-Lane Roadway.....	13
Table II: Beta 40 LED (Low Driver Setting) a) Floor Level Illuminance, b) Power Consumption, and c) Illuminance at 2, 4, & 6 Feet Heights on Measurement Grid	47
Table III: Beta 40 LED (Medium Driver Setting) a) Floor Level Illuminance, b) Power Consumption, and c) Illuminance at 2, 4, & 6 Feet Heights on Measurement Grid.....	49
Table IV: Beta 40 LED (High Driver Setting) a) Floor Level Illuminance, b) Power Consumption, and c) Illuminance at 2, 4, & 6 Feet Heights on Measurement Grid.....	51
Table V: Beta 60 LED (Low Driver Setting) a) Floor Level Illuminance, b) Power Consumption, and c) Illuminance at 2, 4, & 6 Feet Heights on Measurement Grid	53
Table VI: Beta 60 LED (Medium Driver Setting) a) Floor Level Illuminance, b) Power Consumption, and c) Illuminance at 2, 4, & 6 Feet Heights on Measurement Grid.....	55
Table VII: Beta 60 LED (High Driver Setting) a) Floor Level Illuminance, b) Power Consumption, and c) Illuminance at 2, 4, & 6 Feet Heights on Measurement Grid.....	57
Table VIII: Dolphin 90 LED a) Floor Level Illuminance, b) Power Consumption, and c) Illuminance at 2, 4, & 6 Feet Heights on Measurement Grid.....	59
Table IX: Dolphin 120 LED a) Floor Level Illuminance, b) Power Consumption, and c) Illuminance at 2, 4, & 6 Feet Heights on Measurement Grid.....	61
Table X: HPS 150 a) Floor Level Illuminance, b) Power Consumption, and c) Illuminance at 2, 4, & 6 Feet Heights on Measurement Grid.....	63
Table XI: HPS 250 a) Floor Level Illuminance, b) Power Consumption, and c) Illuminance at 2, 4, & 6 Feet Heights on Measurement Grid.....	65

Acknowledgements

The research reported in this document was performed through the Alaska University Transportation Center under Grant 00003238 US DOT RITA UTC by the Institute of Northern Engineering and the Department of Electrical and Computer Engineering, University of Alaska Fairbanks.

Richard W. Wies, Associate Professor of Electrical and Computer Engineering, University of Alaska Fairbanks, was the principal investigator. The other authors of this report are Michael D. Elbert and Dalton Ellingson, Undergraduate Research Assistants.

The work was performed under the supervision of Professor Wies.

The authors would like to thank Phil Sanders of Fairbanks Public Works for providing high pressure sodium and Beta LED street lights and James Cahn of Everlight Americas for providing their Dolphin model LED street lights for testing. The authors would also like to thank Beta LED and Everlight for providing manufacturer's specifications for their LED based street light products that were tested in this project.

The authors would also like to thank Professor Meriam Karlsson and graduate research assistant Yosuke Okade of the School of Natural Resources and Agricultural Sciences, as well as the Alaska FFA program director, Jeffrey Werner for providing access to their Apogee PS-300 spectroradiometer which was used to evaluate the light spectrums for this study. And lastly, the authors would like to thank the Alaska Center for Energy and Power for providing the garage space in the Energy Center, as well as Joel Bailey and Paul Brown, Institute of Northern Engineering and College of Engineering and Mines Technical Services, for their help in clearing the garage space.

Abstract

This report documents results of testing LED and HPS street lights to determine if they meet AASHTO standards for illumination of roadways. Two power levels of LED, Everlight LED, and traditional high pressure sodium (HPS) street lights were tested and compared to AASHTO roadway illuminance specifications. Each light was tested for road level illuminance, power consumption, and light spectrum at all possible settings with a 120 volt supply. A grid 40 feet along the roadway by 30 feet (20 feet across the roadway and 10 feet beside the roadway) was used for the illuminance testing. The light was mounted at a 10 foot height with the center of light located on one end of the 40 foot dimension and 20 feet from one side of the 30 foot dimension. Measurement points were set up at 2 foot intervals on radial lines from the center of light spaced 15 degrees apart. The results showed that LED street lights provide predominantly blue spectrum light with less than half the illuminance of HPS street lights, but at 20% to 75% of the power consumption. These findings suggest that LED street lights need improvement in illuminance and quality before these lights are recommended for use on Alaskan roadways.

Summary of Findings

The ultimate question that this project seeks to answer is, “Can LED street lights provide usable and safe illumination of Alaska roadways based on AASHTO standards?” The results of this project showed that LED street lights can provide usable light with much lower energy consumption than HPS street lights, but at light intensities much less than HPS street lights. However, in many applications LED street lights would need to be spaced closer together than HPS lights in order to meet AASHTO standards for illumination of roadways for various surface types. Additional testing of the light spectrum indicates that LED street lights tested have a predominantly blue spectrum, yet are considered a white light. Visual observations by the researchers on this project suggest that the LED light quality is such that it causes reflections that make it difficult to see objects clearly, particularly for those wearing glasses and possibly due to ultraviolet coating on the lenses. These findings suggest that LED street lights need improvement in illuminance and color quality before they are considered as strict replacements for HPS street lights.

CHAPTER 1 - INTRODUCTION AND RESEARCH APPROACH

Problem Statement and Research Objective

AKDOT&PF has a specific research need for evaluating the level and quality of light produced from LED based street lighting. Street lights use a lot of energy, especially when nights are more than 12 hours long. Communities in Alaska are exploring how light-emitting diode (LED) technology, already popular in many devices, from flashlights to electronic billboards, might be applied to city-wide lighting systems. Some researchers and roadway lighting professionals suggest that under ideal conditions, an LED system might save 50% to 75% more energy than a traditional streetlight system [1-2]. Corresponding with the specific research needs of AKDOT&PF and to verify the findings of other researchers and lighting professionals on the viability of LED technology for roadway lighting, the UAF INE team, led by Professor Richard Wies, will address the following specific project objectives:

- 1) Determine if LED based street lighting meets American Association of State Highway and Transportation Officials AASHTO roadway illuminance standards [3] by monitoring and recording the illuminance on a defined roadway grid.
- 2) Determine the relative energy use and color quality of LED based street lighting by monitoring and recording the power consumption and photometric light color spectrum.
- 3) Explore the possibilities of replacing traditional high-pressure sodium (HPS) street lights in urban areas of Alaska with LED based street lights through measurement comparisons.

Scope of Study

The cities of Fairbanks, North Pole, Anchorage and a few other smaller communities in Alaska have already started to replace conventional HPS street lights with LED street lights under the premise that there is considerable energy savings, in some cases as much as 75%. However, it is known that the light output levels from radiated light (illuminance) of the LED based street lights are about 1/3 to 1/2 of that of the HPS lights. What is not known are the quality, the spectrum, and the longevity of LED lighting. Individual LED lights can be designed and light diffused to create specific spectrums and patterns of light, but for some individuals the light spectrum could impact their ability to clearly see objects in the roadway. The benefit of LEDs is that the spectrum and pattern of light can be tuned for the specific application. This

project workplan seeks to answer those questions for the AKDOT&PF which needs research support in determining if current LED street lighting technology meets AASHTO national roadway illuminance standards. Results from this research will aid the AKDOT&PF in determining if current and future LED street lighting technology meets these national standards and can be safely used on Alaskan highways and city streets. This workplan will result in the following benefits to the State of Alaska: (1) improve the safety of passengers on Alaska roadways, and (2) decrease the long term costs through the use of street lighting which meets AASHTO national roadway illuminance standards.

Expected outcomes from this workplan are: (1) a review of current LED street lighting technology and research in the field, (2) a review of current AASHTO national roadway illuminance standards, and (3) a measurement and visibility based determination of the level and quality of light produced from LED based street lighting in comparison to HPS lights to determine if it meets AASHTO national roadway illuminance standards.

Under the right conditions, LEDs can have a longer performance life. In general, the devices tend to be less fragile, and they switch on and off quickly. Many believe LED technology is the next step, after fluorescents, in efficient indoor lighting for the United States. And now LED lighting technology has pushed its way into the street lighting market in an attempt to replace high pressure sodium HPS lamps. But converting an entire existing street lighting system to LED's isn't as simple as switching out a bulb; LED's require entirely different circuitry and power supply designs. LED systems are more sensitive to changes in power supply. Just installing the new equipment can cost a city several million dollars in immediate capital costs. In warm environments (XX – XXF) LED light systems can overheat, burning out circuitry and requiring frequent, expensive repairs. Alaska may have an advantage here; our lower environmental temperatures may be ideal for LEDs.

Another concern is how much light LED's actually shed on a city street. In some places that have adopted them, people perceive that the LED's produce less light than the old lamps, and the light available does not improve visibility as well. Light emitted by an LED fixture produces a much smaller "circle" of light than HPS lamps; some argue that this will require more lights placed closer together, increasing capital and energy costs.

Research Approach

Pursuant to the research need described above, the UAF team, lead by Professor Richard Wies revised its previous workplan on the project conducted in collaboration with UAA entitled Economical Analysis of Alaskan Street Lights by Using Light-Emitting Diode (LED) Technology to focus specifically on comparing HPS street lights and LED street lights. We also performed a literature search of previous testing results and past experiences with visual monitoring and physical measurements of LED street lighting technology.

The testing was conducted on the HPS and LED street lights using the Illumination Engineering Society IES LM-79 standards [4] and included:

- 1) illuminance (foot-candles) at various points along a radial surface grid (the grid should cover at least 4 times the light mounting height down the road from the light and 2 times the mounting height across the road and 1 times the mounting height on the sidewalk side).
- 2) visible light spectrum (color) using a photometer. This information is pertinent to evaluation of color perception and psychological impacts under LED light.
- 3) pattern recognition by camera and visual (quality) observations, and
- 4) power consumption (watts) with a wattmeter.

Street lights to be compared include a IES Type II 150 watt HPS, a IES Type III 250 watt HPS, two power levels of IES Type II LED, and two power levels of IES Type III luminaires that manufacturers claim to provide acceptable illuminance based on the IES and the International Commission on Illumination or Commission Internationale de l'Eclairage CIE photopic light spectrum standards which are currently used by AASHTO. The normalized photopic light spectrum shown in black in Figure 1 [5] below is the cone-activated response of the human eye to well-lit conditions between wavelengths of 380 and 780 nm based on the CIE 1931 colorimetric observer standard [1, 3, & 6]. The normalized scotopic light spectrum shown in green in Figure 1 [5] is the rod-activated response of the human eye in low-level light (civil twilight). In this study the photopic light spectrum was used for the illuminance measurements based on IES and CIE specifications for roadway lighting, while the light spectrum

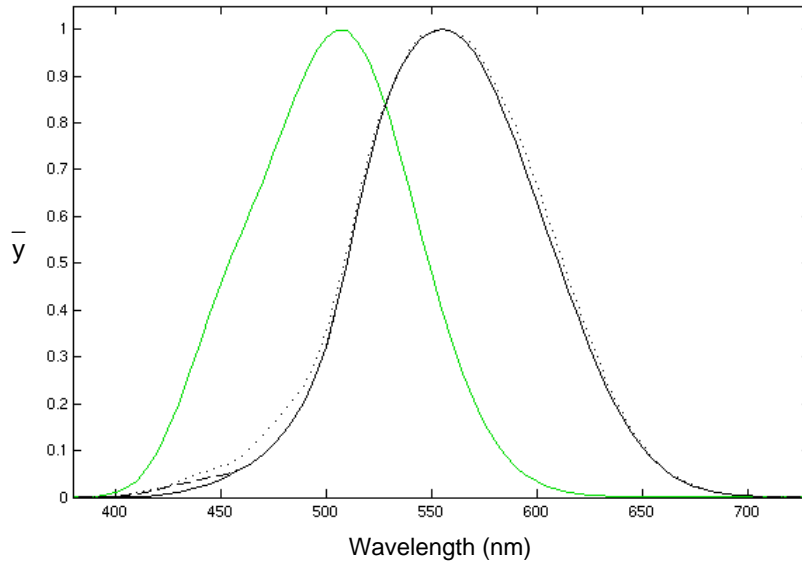

Figure 1: Normalized photopic (black) and scotopic (green) light spectrums. [5] The photopic light spectrum includes the CIE 1931 standard [6] (solid), the Judd-Vos 1978 modified data [7-9] (dashed), and the Sharpe, Stockman, Jagla & Jägle 2005 data [10] (dotted). (Adapted from [5]) measurements include both photopic and scotopic weightings at each wavelength based on the specifications of the spectroradiometer.

Street Light Illuminance, Power Consumption, and Spectrum Measurement Setup

Our testing facility is in the Mineral Industry Research Lab MIRL garage at the Alaska Center for Energy and Power. This is a high bay facility so we configured the lights at a 10 foot elevation above the garage floor similar to the actual street application. The light was mounted at a 10 foot height with the center of light located on one end of the 40 foot dimension, 20 feet from the road side and 10 feet from the pedestrian path side of the 30 foot dimension. Measurement points were set up at 2 foot intervals on radial lines from the center of light spaced 15 degrees apart as illustrated in Figure 2.

The illuminance measurements in footcandles recorded using the Extech HD450 NIST calibrated illuminance meter were used to determine whether HPS street lighting systems retrofitted with LED luminaires will meet AASHTO minimum standards for roadway illuminance in footcandles provided in [3, Table 3-5a] (see Appendix A, page 20). The lighting test arrangement includes the most common lighting layouts (mounting height, spacing, and lateral offset) found in the lighting systems the city of Fairbanks is planning to retro-fit with LED

streetlights. The power consumption measurements recorded using the Fluke 43B power quality analyzer were used to determine the energy savings due to using the LED street lights rather than HPS street lights. The light spectrum measurements recorded in W/m^2 using an Apogee PS-300 specification sheets for the Extech HD450 light meter, Fluke 43B power analyzer, and Apogee PS-300 spectroradiometer are shown in Appendix A2, A3, and A4, respectively.

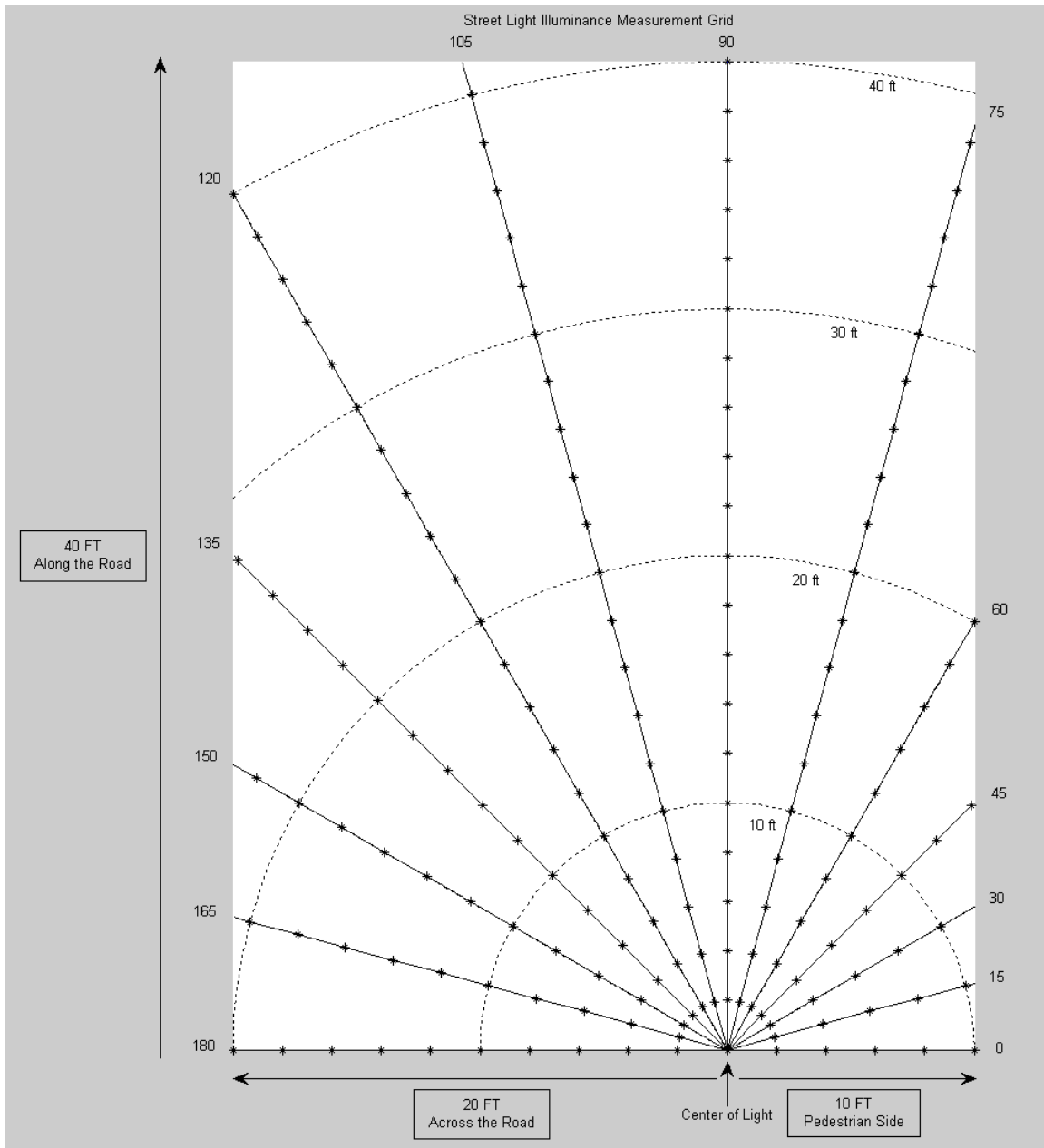

Figure 2: Street Light Illuminance Measurement Grid

Two formats of Beta Generation B Type III LED street lights (40 and 60 LED) with three driver settings each used in the current pilot study in Fairbanks, a American Electric Lighting 250W HPS, and a General Electric 250W HPS street light were made available for testing as provided by the City of Fairbanks Public Works and Facilities through Phil Sanders, Fairbanks Facilities Manager and LED Street Light Project manager. Fairbanks is looking to replace over 2900 HPS street lights with LED street lights in Fairbanks and North Pole with a \$3.31M grant through the Highway and Bridge Stimulus Contingency Project funds. The city is looking for empirical data in order to specify and verify that the LED street lights meet the required standards before ordering the replacement lights. Two Everlight Americas IES Type II LED street lights in the (90 to 100 W) and (120 to 145 W) range were sent directly to the university from Everlight Americas Inc, and were also tested as part of this study. The manufacturer's specifications sheets for the four different lights tested are provided in Appendix A.

The street lights were configured to operate off of 120V single-phase AC, which was readily available at the testing location. A 120V to 240V 1 kVA transformer was used to drive the HPS250 which requires 240V to fire the ignitor in the configuration provided. The quantitative and qualitative results of this testing summarized in the following sections provided the data necessary to assess the current LED street light technology and compare with HPS street lights and document their performance versus the HPS street lights for this application.

CHAPTER 2 - FINDINGS

LED and HPS Street Light Testing Results

The following sections document the results of testing the photopic illuminance, power consumption, and light spectrum of LED and HPS street lights.

Photopic Illuminance and Power Consumption Results

The photopic illuminance results were recorded in Tables II-XI a) in Appendix B on pages 47, 49, ..., 65 for the LED and HPS based street lights using the Extech HD450 NIST calibrated illuminance meter at the measurement points located at the floor level within the grid specified in Figure 2. Stray light measurements taken using the 40 fc range before the initial test with all the luminaires turned off in the garage indicated 0.00 fc at the floor level at all measurement points on the grid. The power consumption and power quality measurements were recorded in Tables II-XI b) in Appendix B on pages 47, 49, ..., 65 at the start, middle and end of each test using the Fluke 43B power quality analyzer. In addition to the illuminance measurements taken at the floor level, illuminance measurements were also taken at heights of 2, 4, and 6 feet above the floor at measurement points set up at 4 foot intervals on radial lines from the center of light spaced 45 degrees apart on the same measurement grid shown in Figure 2, but with fewer points. These results are documented in Tables II-XI c) in Appendix B on pages 48, 50, ..., 66. Note that the range on the illuminance meter was increased to 400 fc for some of the measurement points, particularly for the 2, 4, and 6 feet heights above the floor and the higher intensity HPS lights, since the illuminance values exceeded the 40 fc range. These points are indicated by an asterisks (*) in Tables II-XI c).

In order to provide a good visual representation of the illuminance results over the measurement grid at the floor level as tabulated in Tables II-XI a), a series of color filled contour plots shown in Figures 3-12 in Appendix C on pages 68-77 were constructed to show the lines of isoilluminance at the floor level. A color map scaled from 0 to 40 fc (the next nearest 5 fc to the maximum for all lights tested) is provided to the right of each contour plot to show the illuminance level (not the actual color of the light). A datatip is also included on each plot indicating the position $\langle x, y \rangle$ in feet from the center of light and illuminance $\langle z \rangle$ in footcandles at the center of light $\langle 0, 0 \rangle$ point on the grid.

For the measurements taken at the floor level (0 ft) and 2, 4, and 6 feet heights as tabulated in Tables II-XI a) and c), a series of surface plots were constructed as shown in Figures 13-22 in Appendix C on pages 78-87. Each figure shows the 0, 2, 4, and 6 feet height illuminance results for each light tested at the specific driver setting (Beta LEDs only) on the measurement grid in Figure 2. The z axis range (measured in footcandles) on each of the four plots (a-d) in each figure are 40, 60, 100, and 225, respectively, based on the next nearest 5 to the maximum value of all lights tested. A color map scaled from 0 to 225 fc is provided next to each surface plot to show the illuminance (not the actual color of the light). A datatip is also included on each plot indicating the position $\langle x, y \rangle$ in feet from the center of light and illuminance $\langle z \rangle$ in footcandles of the highest illuminance value within the measurement grid. Note that this is not always at the center of light $\langle 0, 0 \rangle$ point on the grid.

In order to assess the illuminance levels of the street lights at heights commonly used on local roadways, the surface level measurements with the light at a height of 10 ft were translated to measurement grids for heights of 20 ft and 30 ft. This was accomplished by creating $1/r^2$ and negative exponential curve fits to radial distance vs. illuminance data along each of the radial lines for the HPS and LED street light, respectively. The new measurement grids were setup to cover at least 4 times the light mounting height down the road from the light and 2 times the mounting height across the road and 1 times the mounting height on the sidewalk side as described in the research approach. A series of color filled contour plots shown in Figures 23-32 in Appendix C on pages 88-97 were constructed to show the lines of isoilluminance at the floor level for light mounting heights of a) 20 ft and b) 30 ft. A color map scaled from 0 to 40 fc (the next nearest 5 fc to the maximum for all lights tested at the 10 foot height) is provided to the right of each contour plot to show the illuminance level (not the actual color of the light). A datatip is also included on each plot indicating the illuminance $\langle z \rangle$ in footcandles at the center of light $\langle 0, 0 \rangle$ point on the grid.

Light Spectrum Results

The light spectrum plots shown in Figures 33-39 in Appendix D on pages 99-105 were recorded in Watts/meter² across the visible photopic light spectrum (380 nm to 780 nm) for the LED and HPS based street lights using the Apogee PS-300 spectroradiometer. A color map scaled from 0 to 40 fc (the next nearest 5 fc to the maximum for all lights tested) is provided below each plot to show the actual colors across the light spectrum. The eye of the

spectroradiometer was located at the floor for HPS lights and 6 feet level for LED lights at the center of light in Figure 2 in order to achieve a scalable power spectral density for the lower lumen output of the LED lights on the Apogee PS-300 computer interface.

The spectral power density values recorded at each wavelength were converted to footcandles for the plots and the total illuminous flux over the visible photopic light spectrum (printed in the title for each plot) was calculated using Equation 1 [5],

$$FC = \frac{683.002 \text{ lm/W}}{10.764 \text{ ft}^2/\text{m}^2} * \int_0^\infty \bar{y}(\lambda) J(\lambda) d\lambda = \frac{683.002 \text{ lm/W}}{10.764 \text{ ft}^2/\text{m}^2} * [\bar{y}(\lambda) \bullet J(\lambda)] \quad \text{Equation 1}$$

where FC is the total illuminous flux [footcandles] over the visible photopic light spectrum, $\bar{y}(\lambda)$ is the discrete value of the normalized luminosity function (≤ 1) at the given wavelength based on the CIE 1931 photopic spectrum [6, 11], and $J(\lambda)$ is the discrete value of the power spectral density [W/m^2] at the given wavelength. The integral is simply calculated as the inner or dot product of the luminosity function and the power spectral density vectors if the discrete values of the power spectral density are known at specified wavelengths [12]. The 683.002 lm/W is the conversion factor for the photopic spectrum [13]. This is determined by using the definition of a lumen 683 lm per W of radiant energy at a frequency of 540 THz or 555.016 nm, and then dividing 683 lm/W by luminosity function value $\bar{y}(\lambda) = 0.999997$ at 555.016 nm [14].

Overall Analysis

The following sections contain analysis of the testing results for the photopic illuminance, power consumption, and light spectrum of LED and HPS street lights.

Photopic Illuminance Analysis

The photopic illuminance results for the Beta 40 LED light in Tables II-IV a) showed a ring of higher level illuminance at 8 feet for the 0° and 15° radial lines, and 6 feet at 180° radial line, but not larger than the illuminance at the center of light with a decaying exponential fit to the radial distance vs. illuminance data along each of the radial lines from the center of light. The Beta 60 LED light photopic illuminance results in Tables V-VII a) showed a ring of higher level illuminance at 8 feet for the 0°, 15°, and 180° radial lines, but not larger than the illuminance at the center of light with a decaying exponential fit to the radial distance vs. illuminance data along each of the radial lines from the center of light. The Dolphin 90 LED light photopic

illuminance results in Table VIII a) showed rings of higher level illuminance than at the center of light at 2 and 4 feet for all radial lines at and above 120° and 6 feet for all radial lines at and above 135°, with the ring of the highest level of illuminance at 4 feet for all radial lines at and above 135° on the roadway side of the grid with a relatively good $1/r^2$ fit as expected to the radial distance vs. illuminance data along each of the radial lines from the center of light. The Dolphin 120 LED light photopic illuminance results in Table IX a) showed rings of higher level illuminance than at the center of light at 2 feet and 4 feet for all radial lines at and above 120°, but with the ring of the highest level of illuminance at 2 feet for all radial lines at and above 120° on the roadway side of the grid with a relatively good $1/r^2$ fit to the radial distance vs. illuminance data along each of the radial lines from the center of light.

The HPS 150 light photopic illuminance results in Table X a) showed rings of higher level illuminance than at the center of light at 2 feet for all radial lines at and above 135° and 4 feet for all radial lines at and above 165°, with the ring of the highest level of illuminance at 2 feet for all radial lines at and above 135° on the roadway side of the grid with a relatively good $1/r^2$ fit to the radial distance vs. illuminance data along each of the radial lines from the center of light. The HPS 250 light photopic illuminance results in Table XI a) showed no rings of higher level illuminance than at the center of light with the best $1/r^2$ fit to the radial distance vs. illuminance data along each of the radial lines from the center of light.

While the Beta and Dolphin LED lights had more uniform light in terms of the illuminance level at the same distance from the center of light on the roadway and sidewalk sides of the grid, the illuminance values in footcandles were less than half of those at the same grid points for the HPS lights. The HPS lights also tended to concentrate more of the light on the roadway side in the traffic lanes as this was visually observed during the testing and is also easily observed by looking at the illuminance values at the 10 feet mark on the 0° and 180° radial lines for the HPS 150 light in Tables X a). All of the lights tested were expected to have a $1/r^2$ fit with respect to illuminance as a function of radial distance from the center of light along each radial line. The best $1/r^2$ illuminance vs. radial distance fit was for the HPS 250 with the HPS 150, Dolphin 120, and Dolphin 90 all fairly comparable, but not quite as good. The Beta LEDs all had more of a decaying exponential illuminance vs. radial distance fit, but a translated $1/r^2$ shape could be observed in the data. The difference between the Beta LED and the Dolphin LED illuminance vs. radial distance fit could be due to a number of factors, but is most likely due to the optics

used to direct the light from the LEDs to concentrate on specific areas of the surface like the middle of traffic lanes. The difference between the HPS 150 and HPS 250 in terms of the $1/r^2$ fit could be accounted for in terms of the shape of the lamp used in the fixture and the optics of the lens which was flat glass in both instances. The HPS 150 used the LU150 with the shorter oval ED23-1/2 lamp shape that tends to concentrate light at points close to, but not directly at the center of light. The HPS 250 used the LU250 with the long cylindrical ED18 lamp shape that illuminates more nearly along a $1/r^2$ from the center of light.

Power Consumption Analysis

The power consumption results for the LED based street lights versus those for the HPS based street lights in Tables II-IX b) and Tables X-XI b), respectively, show that the LED based lights use 50% - 80% less power than the same HPS based light used in a specific roadway lighting application. The Beta 40 LED light power consumption results in Tables II-IV b) show that the light consumed as little as 22 W on the low driver setting and as much as 47 W on the high driver setting. The Beta 60 LED light power consumption results in Tables V-VII b) show that the light consumed as little as 98 W on the low driver setting and as much as 125 W on the high driver setting. The Dolphin 90 and Dolphin 120 LED light power consumption results in Tables VIII-IX b) show that the lights consumed about 90 W and 137 W, respectively. The HPS 150 and HPS 250 light power consumption results in Tables X-XI b) show that the lights consumed about 194 W and 280 W, respectively. It was also observed that all the LED based street lights consumed about 1 W more for a short period of time after starting up, while the HPS lights tended to take about 10 minutes to warm up after startup consuming a higher level of power and then dropping off as the testing time progressed. We tried to capture both scenarios in the tabulated data, but when the test was conducted for the HPS 250, the light was already warmed up from a previous test run. We did notice and document the warm up effect during that test run.

Light Spectrum Analysis

The stray light spectrum shown in Figure 33 taken before the initial spectrum test with all the illuminaires turned off in the garage indicated very low power spectral density values across the photopic spectrum. The photopic power spectral density plots illustrate two important results with respect to HPS and LED street lights. Examining Figures 34-36, the first important result is

that the LED street lights have a significant amount of predominantly blue spectrum light peaking around the 450 nm wavelength with a lower (about half) and relatively flat spectrum across the green, yellow, orange, and red parts of the spectrum from 500 to 650 nm. Examining Figures 37 and 39, the second important result is that the HPS street lights have spectral power density peaks in the yellow, orange and red part of the spectrum as well as a significant peak (double the visible spectrum peaks) of near infrared light around 820 nm. Figure 38 shows the stray light spectrum measurements across the spectrum of data taken including the lower half of the near infrared spectrum from 740 nm to 850 nm. The large power spectral density peak in the near infrared spectrum for the HPS lights indicates a significant energy loss component contributing to infrared radiation rather than visible light.

CHAPTER 3 - INTERPRETATION, APPRAISAL, AND APPLICATIONS

General Recommendations

AASHTO Standards

Based on the findings for photopic illuminance using the IES LM-79 testing standards [4] at the road surface for on street light mounting heights of 10, 20, and 30 feet presented in Chapter 2, the LED street lights do not meet AASHTO roadway minimum photopic illuminance standards as listed in Table 3-5a from Roadway Lighting Design Guide [3] (see Appendix A1). In order to meet the standards the average illuminance along longitudinal lines in the middle of the lanes over one luminaire cycle (distance between light poles on the same side of the road) must be greater than the prescribed minimums for different classes and surfaces of roads using a maximum of 25 ft between measurement points [3].

In our study the illuminance values at rectangular grids points at two feet intervals along four longitudinal lines (two for each lane) at $\frac{1}{4}$ and $\frac{3}{4}$ of the lane widths (12 feet) were interpolated from the measured data at a 10 feet mounting height for mounting heights of 20 and 30 feet and averaged to determine the average illuminance as listed in Table I below.

Table I: Average Illuminance on Two-Lane Roadway

Illuminaire	Average Illuminance (fc) for Mounting Height	
	20 Feet	30 Feet
Beta 40 Low	0.1439	0.0593
Beta 40 Mid	0.2103	0.0853
Beta 40 High	0.2865	0.1189
Beta 60 Low	0.4951	0.2073
Beta 60 Mid	0.5202	0.2152
Beta 60 High	0.5530	0.2300
Dolphin 90	0.3737	0.1849
Dolphin 120	0.5536	0.2628
HPS 150	0.7290	0.3051
HPS 250	1.3354	0.5536

Our results indicate that the Beta 40 LED and Beta 60 LED on the low, mid, and high driver setting and the Dolphin 90 and Dolphin 120 LED street lights do not meet the AASHTO requirements for minimum average illuminance for local roadways for all land use (commercial, intermediate, residential) and pavement types (R1-R4) at a 30 feet mounting height. The HPS

150 only meets the residential land use minimum for R1 pavements, while the HPS 250 residential land use minimums for R1-R4 pavements and the intermediate land use minimum for R1 pavements at the 30 feet mounting height. If the mounting height is lowered to 20 feet, the Beta 40 LED street lights on the low, mid, and high driver settings do not meet the AASHTO requirements for minimum average illuminance for local roadways for all land use and pavement types. The Dolphin 90 meets the AASHTO requirement for local residential roadways with R1 pavement type, while the Dolphin 120 meets residential land use minimums for R1-R4 pavements and the intermediate land use minimum for R1 pavements at the 20 feet mounting height. The HPS 150 and HPS 250 street lights exceed the AASHTO requirements for minimum average illuminance for local roadways in all categories at the 20 feet mounting height, except for the HPS 150 for commercial land use with R2-R4 pavement types.

Given the fact the HPS based street lights are providing more illuminance than the required minimum average, another approach to energy savings could be the reduction in the supply voltage level and even replacing higher wattage HPS fixtures with lower wattage ones. The distance between light poles for a local Fairbanks roadway would need to be decreased by as much as 1/3 for light mounting heights of 30 feet in order for the LED based street lights tested to meet all the minimum average illuminance standards for local roadways for all land use and road pavement types. Also note that this does not take into account the degradation in the illuminance of the LEDs over time, so for design purposes a safety factor of say 1/2 the current distance between poles might need to be used for LED street lights and/or mounted at a lower height.

Power Consumption and Energy Savings Potential

The energy savings potential of LED street lights can be determined based on simple payback relative to the cost of continuing to operate and maintain the existing HPS street lights versus capital and installation replacement and operating costs for the LED street lights. Let's consider the scenario of replacing 1000 HPS 150 street lights with Beta 60 LED street lights on the high driver setting as tested at a cost of \$1000 each, with \$100 per light in installation costs and a 36% reduction in power consumption from 195 W to 125 W. Let us also assume that the HPS lamp and LED light bar replacement schedule is roughly the same in economic terms. For electricity costs at \$0.15 per kW-hr and considering a daily average operating time of 12 hours based on summer and winter daylight hours, the annual electricity costs savings is:

$$\begin{aligned} \text{Annual COE Savings} &= (\text{COE}_{\text{HPS}} - \text{COE}_{\text{LED}}) * 1000 = \\ &(\$0.15/\text{kW-hr})(0.195 \text{ kW} - 0.125 \text{ kW}) * 8760 \text{ hr/yr} * 1000 = (\$128.12 - \$82.13) * 1000 = \\ &\$45.99 * 1000 = \$45,990.00 \end{aligned}$$

If we first assume that the lights can be mounted on the existing poles without the need to add additional poles to decrease the distance between illuminaires and interest free money (grant or part of the cities capital budget), then the total capital cost to replace the HPS street lights with LED street lights is:

$$\begin{aligned} \text{Replacement Costs} &= (\text{Capital Cost} + \text{Installation Cost}) * 1000 = (\$1000 + \$100) * 1000 = \\ &\$1100 * 1000 = \$1.1\text{M} \end{aligned}$$

The simple payback based solely on annual electricity savings is:

$$\text{Simple Payback} = \text{Annual COE Savings} / \text{Replacement Costs} = \$1.1\text{M} / \$45.99\text{k} = 23 \text{ years}$$

There is no need to even pursue further payback analysis including the cost of adding additional poles or including interest as the payback will only increase in years.

Of course we could also argue that the carbon footprint is reduced by 36% based on the energy savings, but if the carbon footprint of manufacturing the new LED street lights and installing additional poles is considered, then that would also cancel out the carbon footprint reduction due to energy savings.

Color Spectrum

The predominantly blue color spectrum and the quality of the light from LED street lights observed during the testing also raises concerns. The predominantly blue spectrum light at a shorter wavelength and higher color temperatures tends to cause visually impairing reflections and halos around objects for those wearing prescription glasses. This is most likely due to ultraviolet protective coating used on the lenses causing greater refraction of the shorter wavelength light from the lenses. Although the blue color spectrum tends to be the better light from a psychological “happy” perspective, close attention needs to be paid to the color temperature of the light. Using a lower color temperature of say 3800K versus 4000K or 5000K for the shorter wavelength light could improve the quality of the light from LEDs for illumination purposes.

CHAPTER 4 - CONCLUSIONS AND SUGGESTED RESEARCH

Conclusions

This report documented the findings, analysis, and interpretation of testing LED street lights using IES LM-79 standards for road level photopic illuminance, power consumption, and light spectrum to support AKDOT's recommendations concerning their application on Alaska roadways. Two power levels of Beta LED, Everlight LED, and traditional high pressure sodium (HPS) street lights were tested and compared to AASHTO roadway illuminance specifications. The results showed that LED street lights provide predominantly blue spectrum light with less than half the illuminance of HPS street lights, but at 20% to 75% of the power consumption.

Three distinct conclusions can be drawn from these findings:

- 1) Two of the LED street lights tested (Beta 40 and Dolphin 90) need improvement in minimum average illuminance along the roadway in order to meet AASHTO standards. This would mean that the Beta 40 LED light would need to operate on the high driver setting and that we would need to install a Dolphin 120 LED light at a minimum to avoid the need to space the poles closer together.
- 2) The marked decrease in power consumption achieved by performing a strict replacement of an HPS street light with an LED street light that meets AASHTO standards given the current pole placement provides a considerable reduction in annual electricity costs. However, the simple payback given the capital and installation cost of the LED lamps has been shown to exceed 20 years given 1000 lamps at \$1100 each including installation and a \$0.15/ kW-hr energy cost.
- 3) Reduction in the color temperature of LED street lights is needed to help alleviate the reflection or halo effect that researchers on this project and others observed with the 4000 K or 5000 K color temperature of the shorter wavelength blue spectrum light. This is particularly an issue for those wearing prescription glasses with ultraviolet protective coating that refracts more of the shorter wavelength light.

In general these findings suggest that LED street lights need improvement in illuminance and color quality before they are considered as strict replacements for HPS street lights. To that end,

increased illuminance will likely require the use of more LEDs resulting in higher power consumption and less energy savings over continuing to use the HPS street lights.

Suggested Research

Further investigation and testing in the area of LED street lighting should be conducted as follows:

- 1) The testing procedures for LED street lights with a significantly different light color spectrum than HPS lights are slightly different than HPS lights. Consequently, there is a need to evaluate the scotopic and photopic spectrums independently of each other as documented in [1]. The IES is currently working on solid-state lighting addendums to RP-16-05: Nomenclature and Definitions for Illuminating Engineering as part of the IES LM-69-95 (CIE TC1-69): IES Approved Guide for the Interpretation of Roadway Luminaire Photometric Reports that includes light quality (scotopic vs. photopic spectrum and temperature) as part of the procedures for LED roadway lighting. AASHTO is also planning to change its national standards to accommodate LED street lighting.
- 2) The new Beta Edge and other brands of LED street lights with the IES Type III light engine should be evaluated using the new testing procedures and standards to determine if they meet AASHTO minimum average illuminance and light quality standards.
- 3) Professional studies of the effect LED roadway lighting on vision due to the shorter wavelength light in the blue spectrum should continue so that more cases of impaired vision can be documented and adjustments made to the color quality of LED street lighting.
- 4) Investigate the possibility of lowering the power consumption of existing HPS street lights by reducing the supply voltage and/or lamp wattage.

REFERENCES

- [1] Josefowicz, Jack & Ha, Debbie, tech. review by Berman, Samuel D., Nov. 2008, "Vision & Exterior Lighting: Shining Some Light on Scotopic & Photopic Lumens in Roadway Conditions," LED Roadway Lighting Ltd., Halifax, NS, CAN.
- [2] Bryan, Mary, P.E., prep by Cook, Tyson, Project Manager, Sommer, Anna, Project Manager, & Pang, Terrance, Director, Energy Solutions, Jan. 2008, "LED Street Lighting in Oakland, CA," *Application Assessment Report #0714*, Pacific Gas and Electric Company, US DOE Emerging Technologies Program, Oakland, CA.
- [3] Burkett, Karl A., P.E., et al., "Roadway Lighting Design Guide," Oct. 2005, *Publ. GL-6*, American Association of State Highway and Transportation Officials AASHTO, Washington, D.C.
- [4] Dowling, Kevin, Chair, Solid-State Lighting Comm. & Ohno, Yoshi, Technical Coordinator, et al., "Electrical and Photometric Measurements of Solid-State Lighting Products," Jan. 2008, *IES LM-79-08*, Illuminating Engineering Society, New York, NY.
- [5] Luminosity Function, http://en.wikipedia.org/wiki/Luminosity_function, accessed July 12, 2010.
- [6] CIE. (1932). *Commission Internationale de l'Éclairage Proceedings*, 1931. Cambridge: Cambridge University Press.
- [7] Judd, Deane B. & Wyszecki, Günter (1975). *Color in Business, Science and Industry* (3rd ed.). John Wiley.
- [8] Vos, J. J. (1978). "Colorimetric and photometric properties of a 2° fundamental observer". *Color Research and Application* **3** (3): 125–128.
- [9] Stiles, W. S., & Burch, J. M. (1955). "Interim report to the Commission Internationale de l'Eclairage Zurich 1955, on the National Physical Laboratory's investigation of colour-matching". *Optica Acta* **2**: 168–181.
- [10] Sharpe, L. T., Stockman, A., Jagla, W., & Jägle, H. (2005). *A luminous efficiency function, $V^*(\lambda)$, for daylight adaptation*. *Journal of Vision*, 5(11), 948-968.
- [11] CIE Documents and Colorimetric Data Tables, <http://www.cie.co.at/main/freepubs.html>, accessed July 12, 2010.
- [12] Poynton, Charles A. (2003). [*Digital Video and HDTV: Algorithms and Interfaces*](#). Morgan Kaufmann.
- [13] 16th General Conference on Weights and Measures, Resolution 3, CR, 100 (1979), and *Metrologia*, **16**, 56 (1980).
- [14] Wyszecki, Günter & Stiles, W.S. (2000). *Color Science - Concepts and Methods, Quantitative Data and Formulae* (2nd ed.), Wiley-Interscience.

APPENDIX A: AASHTO Roadway Lighting Design Illuminance Values; Street Lights, Light Meter, Power Meter, and Spectroradiometer Specification and Data Sheets

AASHTO Roadway Lighting Design Guide, Table 3-5a: Illuminance and Luminance Design Values (English)

Street Light Data/Specification Sheets:

Beta 40 LED (BXSL03034B-UR)

Beta 60 LED (BXSL03051B-VR)

Everlight Americas Dolphin 90 (SL-Dolphin/100240AC/PH90B)

Everlight Americas Dolphin 120 (SL-Dolphin/100240AC/PH120B)

American Electric Lighting 115 HPS (115-15-S-MR-240-R2-FG-DF-HP-UL)

General Electric M-400A HPS (MDCL-25-S-3-A-1-2-F-MC3-2-FU)

Light Meter, Power Analyzer, and Spectroradiometer Data/Specification Sheets:

Extech HD450 Light Meter Specification/Data Sheet

Fluke 43B Power Quality Analyzer Specification/Data Sheet

Apogee PS-300 Spectroradiometer Specification/Data Sheet

AASHTO Roadway Lighting Design Guide, Table 3-5a: Illuminance and Luminance Design Values (English)

24

TABLE 3-5a. Illuminance and Luminance Design Values (English)

Roadway and Walkway Classification	Off-Roadway Light Sources	Illuminance Method					Luminance Method			Additional Values (Both Methods)	
		Average Maintained Illuminance				Minimum Illuminance	Illuminance Uniformity Ratio	Average Maintained Luminance			
		R1	R2	R3	R4			Lavg	Uniformity		Veiling Luminance Ratio
		General Land Use	(foot candles) (min)	(foot candles) (min)	(foot candles) (min)	(foot candles) (min)	(foot candles)	avg/min (max) (5)	cd/m ² (min)	Lavg/Lmin (max)	
Principal Arterials Interstate and other freeways	Commercial	0.6 to 1.1	0.6 to 1.1	0.6 to 1.1	0.6 to 1.1	0.2	3:1 or 4:1	0.4 to 1.0	3.5:1	6:1	0.3:1
	Intermediate	0.6 to 0.9	0.6 to 0.9	0.6 to 0.9	0.6 to 0.9	0.2	3:1 or 4:1	0.4 to 0.8	3.5:1	6:1	0.3:1
	Residential	0.6 to 0.8	0.6 to 0.8	0.6 to 0.8	0.6 to 0.8	0.2	3:1 or 4:1	0.4 to 0.6	3.5:1	6:1	0.3:1
Other Principal Arterials (partial or no control of access)	Commercial	1.1	1.6	1.6	1.4	As uniformity ratio allows	3:1	1.2	3:1	5:1	0.3:1
	Intermediate	0.8	1.2	1.2	1.0		3:1	0.9	3:1	5:1	0.3:1
	Residential	0.6	0.8	0.8	0.8		3:1	0.6	3.5:1	6:1	0.3:1
Minor Arterials	Commercial	0.9	1.4	1.4	1.0		4:1	1.2	3:1	5:1	0.3:1
	Intermediate	0.8	1.0	1.0	0.9		4:1	0.9	3:1	5:1	0.3:1
	Residential	0.5	0.7	0.7	0.7		4:1	0.6	3.5:1	6:1	0.3:1
Collectors	Commercial	0.8	1.1	1.1	0.9		4:1	0.8	3:1	5:1	0.4:1
	Intermediate	0.6	0.8	0.8	0.8		4:1	0.6	3.5:1	6:1	0.4:1
	Residential	0.4	0.6	0.6	0.5		4:1	0.4	4:1	8:1	0.4:1
Local	Commercial	0.6	0.8	0.8	0.8		6:1	0.6	6:1	10:1	0.4:1
	Intermediate	0.5	0.7	0.7	0.6		6:1	0.5	6:1	10:1	0.4:1
	Residential	0.3	0.4	0.4	0.4		6:1	0.3	6:1	10:1	0.4:1
Alleys	Commercial	0.4	0.6	0.6	0.5	6:1	0.4	6:1	10:1	0.4:1	
	Intermediate	0.3	0.4	0.4	0.4	6:1	0.3	6:1	10:1	0.4:1	
	Residential	0.2	0.3	0.3	0.3	6:1	0.2	6:1	10:1	0.4:1	
Sidewalks	Commercial	0.9	1.3	1.3	1.2	3:1	Use illuminance requirements				
	Intermediate	0.6	0.8	0.8	0.8	4:1					
	Residential	0.3	0.4	0.4	0.4	6:1					
Pedestrian Ways and Bicycle Ways ⁽²⁾	All	1.4	2.0	2.0	1.8	3:1					

Notes:

1. Meet either the Illuminance design method requirements or the Luminance design method requirements and meet veiling luminance requirements for both the Illuminance and the Luminance design methods.
2. Assume a separate facility. For Pedestrian Ways and Bicycle Ways adjacent to roadway, use roadway design values. Use R3 requirements for walkways/bikeway surface materials other than the pavement types shown. Other design guidelines such as IESNA or CIE may be used for pedestrian ways and bikeways when deemed appropriate.
3. Lv(max) refers to the maximum point along the pavement, not the maximum in lamp life. The Maintenance Factor applies to both the Lv term and the Lavg term.
4. There may be situations when a higher level of illuminance is justified. The higher values for freeways may be justified when deemed advantageous by the agency to mitigate off-roadway sources.
5. Physical roadway conditions may require adjustment of spacing determined from the base levels of illuminance indicated above.
6. Higher uniformity ratios are acceptable for elevated ramps near high-mast poles.
7. See AASHTO publication entitled, "A Policy on Geometric Design of Highways and Streets" for roadway and walkway classifications.

Roadway Lighting Design Guide

Beta 40 LED (BXSL03034B-UR) and Beta 60 LED (BXSL03051B-VR)

Street Light Specification/Data Sheets

STR-LWY-3M-HT LEDway® Streetlight – Type III Medium Rev. Date: 04/15/10

BetaLED Catalog #: STR - LWY - 3M - HT - C - - - - -

Reset



Notes:

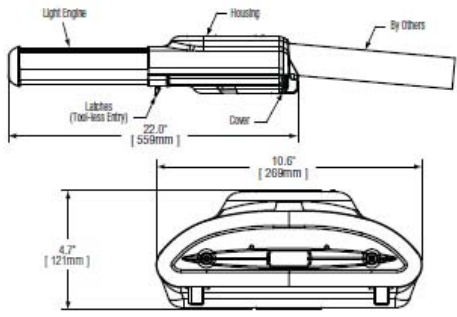

Product	Family	Optic	Mounting	# of LEDs (x 10)	LED Series	Voltage	Color Options	Factory-Installed Options
STR	LWY	3M ¹ 3MB ²	HT ³	04 05 06	C	UL Universal 120-277V UH Universal 347-480V	SV Silver ⁴ BK Black ⁴ BZ Bronze ⁴ PB Platinum Bronze ⁴ WH White ⁴	350 350mA Drive Current ⁵ 43K 4300K Color Temperature ⁶ 700 700mA Drive Current ⁷ DIM5 0-10V Dimming (525mA maximum) ^{8,9} DIM7 0-10V Dimming (700mA maximum) ^{8,9} F Fuse ^{10,11} HL Hi/Low (175/350/525, dual circuit input) ¹² N No Quick Disconnect Harness or Levelling Bubble ¹³ PD Power Door ^{14,15} R NEMA Photocell Receptacle ¹⁶ SC Door Safety Tether ¹⁷

Click here for Utility option.

For additional options, see IP66 spec sheet.

Footnotes

- IESNA Type III Medium distribution
- IESNA Type III Medium distribution with backlight control
- Horizontal lens mount
- Light engine portion of extrusion is not painted and will remain natural aluminum regardless of color selection
- Driver operates at 350mA instead of the standard 525mA providing a lower lumen output and a longer life
- Color temperature per fixture; minimum 70 CRI
- Driver operates at 700mA instead of the standard 525mA providing a higher lumen output and a shorter life
- Control by others
- Refer to [dimming spec sheet](#) for availability and additional information
- Not available with HL option when UH voltage is selected
- When code dictates fusing use time delay fuse
- Refer to [multi level spec sheet](#) for availability and additional information
- Standard product features unless N option is specified; door clips not included
- All connections between door and fixture are shipped unconnected from the factory; door release spring included to open door automatically when the latches are released
- Hinge retaining clips not included as part of this option
- Not available with HL option
- Stainless steel aircraft cable

# of LEDs	Initial Delivered Lumens – Type III Medium @ 6000K			Initial Delivered Lumens – Type III Medium w/ Backlight Control @ 6000K			Initial Delivered Lumens – Type III Medium @ 4300K			Initial Delivered Lumens – Type III Medium w/ Backlight Control @ 4300K			System Watts 120-277V	Total Current @ 120V	Total Current @ 230V	Total Current @ 277V	System Watts 347-480V	Total Current @ 347V	Total Current @ 480V	L ₈₀ Hours* @ 25° C (77° F)				
	B	U	G	B	U	G	B	U	G	B	U	G												
350mA Fixture Operating at 25° C (77° F)																								
40	3,476 (04)	1	1	1	2,259 (04)	0	1	1	3,049 (04)	1	1	1	2,287 (04)	0	1	1	47	0.40	0.22	0.20	53	0.15	0.16	153,000
50	4,248 (05)	2	2	2	3,186 (05)	0	1	1	3,726 (05)	2	2	2	2,795 (05)	0	1	1	64	0.53	0.29	0.25	70	0.20	0.19	141,000
60	5,098 (06)	2	2	2	3,823 (06)	1	2	1	4,472 (06)	2	2	2	3,354 (06)	0	1	1	76	0.62	0.34	0.29	81	0.23	0.20	131,000
525mA (Standard) Fixture Operating at 25° C (77° F)																								
40	4,658 (04)	2	2	2	3,493 (04)	0	1	1	4,085 (04)	2	2	2	3,064 (04)	0	1	1	70	0.59	0.32	0.28	76	0.22	0.20	96,000
50	5,693 (05)	2	2	2	4,270 (05)	1	2	1	4,993 (05)	2	2	2	3,745 (05)	1	2	1	95	0.80	0.42	0.36	101	0.29	0.24	85,000
60	6,831 (06)	2	2	2	5,123 (06)	1	2	2	5,992 (06)	2	2	2	4,494 (06)	1	2	1	113	0.94	0.50	0.42	119	0.34	0.27	79,000
700mA Fixture Operating at 25° C (77° F)																								
40	5,700 (04)	2	2	2	4,275 (04)	1	2	1	5,000 (04)	2	2	2	3,750 (04)	1	2	1	98	0.83	0.44	0.37	104	0.30	0.24	65,000
50	6,967 (05)	2	2	2	5,225 (05)	1	2	2	6,111 (05)	2	2	2	4,583 (05)	1	2	1	124	1.04	0.55	0.46	131	0.38	0.30	56,000
60	8,361 (06)	3	2	3	6,270 (06)	1	3	2	7,333 (06)	2	2	2	5,500 (06)	1	2	2	146	1.23	0.64	0.54	154	0.44	0.34	50,000

* Utilizes magnetic step-down transformer ** For recommended lumen depreciation data see TD-13 *** For more information on the IES BUG (Backlight-Uplight-Glare) Rating visit www.iesna.org/IES/IRatings/TM-15-07/BugRatingAddendum.pdf

© 2010 BetaLED®, a division of Ruud Lighting • 1200 92nd Street • Sturtevant, WI 53177 • 800-236-6800 • www.LEDway.com

Made in the U.S.A. of U.S. and imported parts.
Meets Buy American requirements within the ARRA.



General Description

Fixture housing is all aluminum construction. Standard fixture utilizes terminal block for power input suitable for #2-#14 AWG wire and operates at 525mA. Drive current is field switchable on 40, 50 and 60 LED units (50 & 60 LED units require two drivers). Fixture is designed to mount on 1.25" IP (1.675" O.D.) and/or 2" IP (2.375" O.D.) horizontal tenon and is adjustable +/- 5° to allow for fixture leveling (Includes leveling bubble to aid in this process). Fixture carries a limited five year warranty.

Electrical

Modular design accommodates varied lighting output from high power, white, 6000K (+/- 500K per full fixture), minimum 70 CRI, long life LED sources. 120-277V 50/60 Hz, Class 1 LED drivers are standard. 347-480V 50/60 Hz option is available. LED drivers have power factor >90% and THD <20% at full load. Units provided with Integral 9KV surge suppression protection standard. Quick disconnect harness suitable for mate and break under load provided on power feed to driver for ease of maintenance. Surge protection tested in accordance with IEEE C62.41.2 and ANSI standard 62.41.2.

Finish

Exclusive Colorfast DeltaGuard® finish features an E-Coat epoxy primer with an ultra-durable silver powder topcoat, providing excellent resistance to corrosion, ultraviolet degradation and abrasion. Bronze, black, white and platinum bronze powder topcoats are also available. The finish is covered by our 10 year limited warranty.

Fixture and finish are endurance tested to withstand 5,000 hours of elevated ambient salt fog conditions as defined in ASTM Standard B 117.

Testing & Compliance

UL listed in the U.S. and Canada for wet locations. Consult factory for CE Certified products. RoHS compliant. Meets CALTrans 611 Vibration Testing and GR-63-CORE Section 4.4.1/5.4.2 Earthquake Zone 4. International Dark-Sky Association approved.

Patents

U.S. and International patents granted and pending. BetaLED is a division of Ruud Lighting, Inc. For a listing of Ruud Lighting, Inc. patents, visit www.uspto.gov.

Field-Installed Accessories



Bird Spikes for Light Engine
 XA-BRDSPK60



Bird Spikes Kit for Housing
 XA-BRDSPKHSG

Photometrics

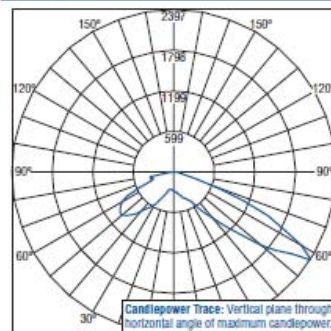

Independent Testing Laboratories certified test. Report No. ITL63266. Candepower trace of 6000K, 40 LED Type III Medium streetlight luminaire with 4,696 initial delivered lumens operating at 525mA. All published luminaire photometric testing performed to IESNA LM-79-08 standards.

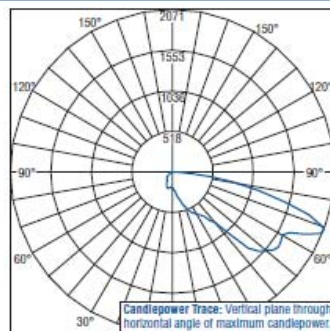

Independent Testing Laboratories certified test. Report No. ITL64192. Candepower trace of 6000K, 60 LED Type III Medium streetlight luminaire with backlight control and 3,178 initial delivered lumens operating at 525mA. All published luminaire photometric testing performed to IESNA LM-79-08 standards.

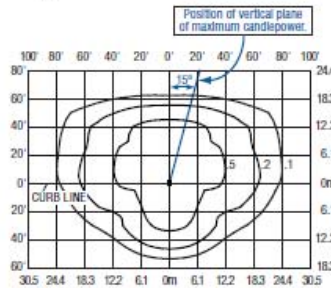

Isofootcandle plot of 6000K, 60 LED Type III Medium streetlight luminaire at 25' A.F.G. Luminaire with 6,831 initial delivered lumens operating at 525mA. Initial FC at grade.

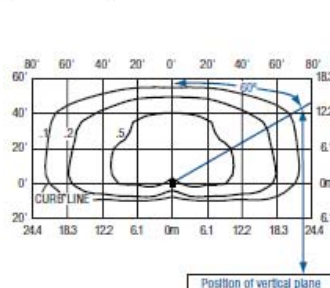

Isofootcandle plot of 6000K, 60 LED Type III Medium streetlight luminaire with backlight control at 25' A.F.G. Luminaire with 5,123 initial delivered lumens operating at 525mA. Initial FC at grade.

LEDway® EPA & Weight Calculations

	Approximate Weight 120-277V*
40-60 LED fixture	16.0 lbs.
EPA	
Horizontal Tenon Mount	
1 fixture	0.685
EPA	
Round External Mount / Square Internal Mount Horizontal Tenons with Fixture(s)	
PT/PD-1H	Single 0.905
PT/PD-2H(90)	90° Twin 1.189
PT/PD-2H(180)	180° Twin 1.590
PT/PD-3H(90)	90° Triple 1.774
PT/PD-3H(120)	120° Triple 1.590
PT/PD-4H(90)	90° Quad 2.178

*Add 5 lbs. for transformer in 347-480V fixtures



© 2010 BetaLED®, a division of Ruud Lighting • 1200 92nd Street • Sturtevant, WI 53177 • 800-236-6800 • www.LEDway.com

Made in the U.S.A. of U.S. and imported parts.
 Meets Buy American requirements within the ARRA.

Everlight Americas Dolphin 90 (SL-Dolphin/100240AC/PH90B) and
Dolphin 120 (SL-Dolphin/100240AC/PH120B) Street Light Specification/Data Sheets



Dolphin Street Lighting Series (Preliminary)

Features

- Light source: High brightness LED
- NO UV or IR light radiation
- Special batwing and asymmetrical light pattern
- $R_a > 60$
- LED illumination flux:
Over 8000 lm@120W
- Optimized heat fins with artistic design
- 100V-240V AC input
- LED Power Consumption up to 120W
- Power Factor $> 99\%$ @110VAC
- Power eff. $> 80\%$
- Long LED lifetime > 35000 hours (L_{70}); 3-year warranty
- Operation temperature: $-20^{\circ}\text{C} \sim 50^{\circ}\text{C}$
- IP 65 for light engine & power supply unit
- Easily upgradeable to higher performance light engine

SL-Dolphin/100240AC
UL certified (E326344)



Typical Applications

- Street Lighting
- Architectural Lighting
- Parking Lot Lighting
- Biological Lighting
- Residential Street Lighting
- Walkway Lighting
- Dock and Pier Lighting
- Public Safety Illumination
- Off-Grid lighting

Housing Picture



Everlight Americas, Inc. <http://www.everlightamericas.com/>
3220 Commander Drive, Suite 100, Carrollton, Texas 75006
Device No. : DMM-0000069 Prepared date: 04-23-2009

Rev. 3 Page: 1 of 11
(972) – 490 – 4008
Prepared by: Felix Tsai



EVERLIGHT AMERICAS, INC.

Code of Product Number

SL – Dolphin / 100240AC / Ph 120 B

1 2 3 4 5 6

- | | |
|--|---|
| <p>1. <u>Product Series</u>
SL: Solid state lighting</p> <p>2. <u>Lighting Module Type</u>
Dolphin: Dolphin street light series</p> <p>3. <u>Input Voltage</u>
100240AC:100~240AC, 50/60 Hz</p> <p>4. <u>Light Engine Type</u>
Ph: SL-Phoenix(Type II)
Tr: SL-Trex(Type II)
Ve: SL-Venus(Type III)</p> | <p>5. <u>LED Power Consumption</u>
60: 60W
90: 90W
120:120W</p> <p>6. <u>Light Engine LED Type</u>
None: A type LED
B: B type LED</p> <p>7. <u>Product Safety Certification</u>
None: UL Certified</p> |
|--|---|

Product Family

Order Code	LED Power Consumption	Light Engine Type
SL-Dolphin/100240AC/Ph60	60W	SL-Phoenix series
SL-Dolphin/100240AC/Tr60		SL-Trex series
SL-Dolphin/100240AC/Ve60		SL-Venus series
SL-Dolphin/100240AC/Ph90	90W	SL-Phoenix series
SL-Dolphin/100240AC/Tr90		SL-Trex series
SL-Dolphin/100240AC/Ve90		SL-Venus series
SL-Dolphin/100240AC/Ph120	120W	SL-Phoenix series
SL-Dolphin/100240AC/Tr120		SL-Trex series
SL-Dolphin/100240AC/Ve120		SL-Venus series
SL-Dolphin/100240AC/Ph120B		SL-Phoenix series
SL-Dolphin/100240AC/Tr120B		SL-Trex series
SL-Dolphin/100240AC/Ve120B		SL-Venus series



EVERLIGHT AMERICAS, INC.

Product Specification

Parameter	Description
Light Source	High Brightness LED
Optical Lens	PMMA Optical Lens ¹
Optical Design	Special Batwing and Asymmetrical Light Patterns
Beam Color	White (4550~5600K)
Housing	Aluminum with Anti-Erosive Material (Metallic Lacquer)
Weight	~10kg with Power Supply Unit
Power Input	100~240 VAC Input
Installation Tube Diameter(OD ²)	60 mm (2.36")
IP Rating	IP 65 for Light Engine & Power Supply

Note:

1. PMMA optical Lens can not be cleaned by organic or acidic solvent.
2. OD: Outer diameter

Everlight Americas, Inc.
3220 Commander Drive, Suite 100, Carrollton, Texas 75006
Device No. : DMM-0000069

<http://www.everlightamericas.com/>
Prepared date: 04-23-2009

Rev. 3 Page: 3 of 11
(972) – 490 – 4008
Prepared by: Felix Tsai



EVERLIGHT AMERICAS, INC.

Electro-Optical-Thermal Characteristics ($T_{Ambient}=25^{\circ}C$)

Parameter	Symbol	Property Unit			Unit
LED Power Consumption	W	~60	~90	~120	Watt
Illumination of LED, A type	Lm	Typical 3360	Typical 4800	Typical 7200	Lm
Illumination of LED, B type				Typical 8000	
1 Fixture Temperature	T_f	~40	~45	~50	$^{\circ}C$
Input Voltage (AC)	VAC	100~240			V
Operating Temperature	T_a	-20~50			$^{\circ}C$
Storage Temperature	T_{stg}	-30~60			$^{\circ}C$

Note:

- The fixture temperature of SL-Dolphin series is measured under good natural convection and at $T_a=25^{\circ}C$.

Product Dimension: 710(L)X325(W)X125(H) mm

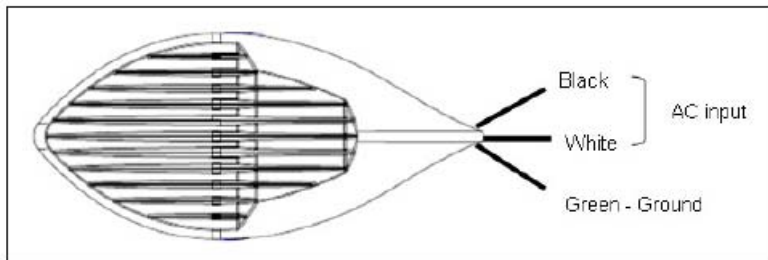
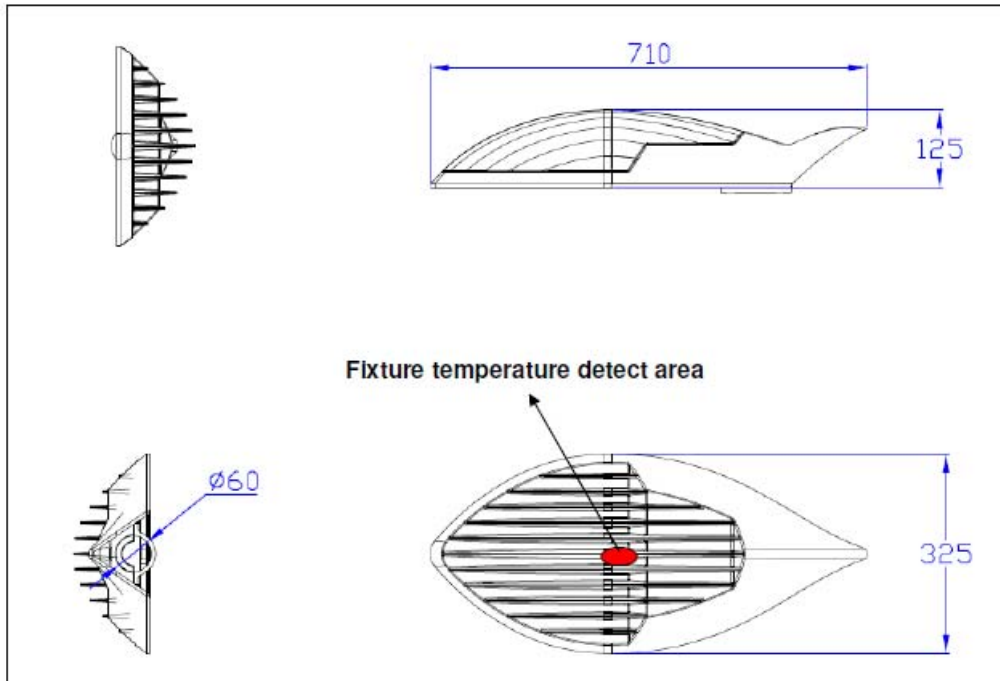



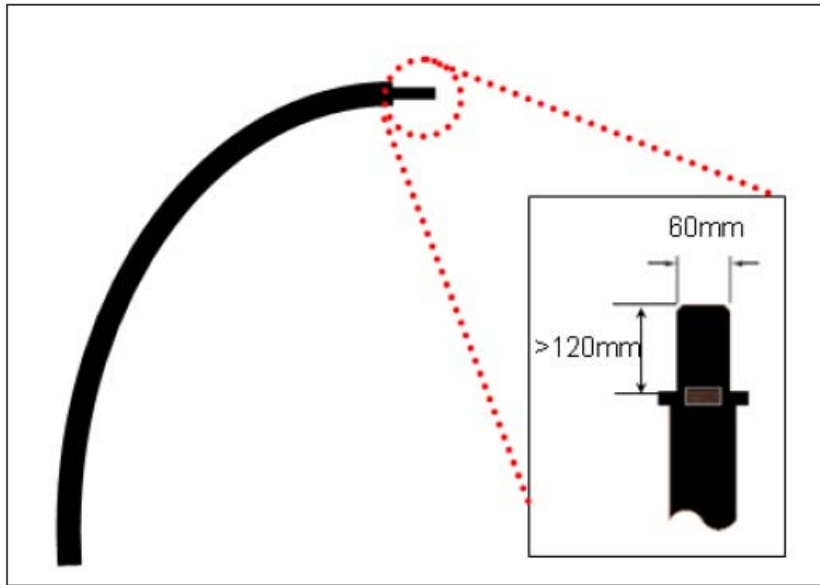

Notes:

1. Dimensions are in millimeters
2. Tolerances unless dimensions ± 2 mm

Installation Pole Specifications

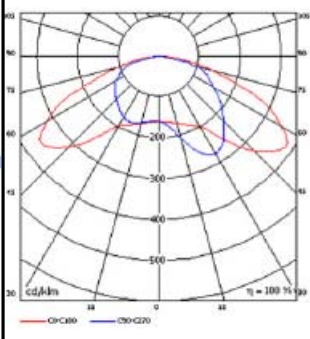
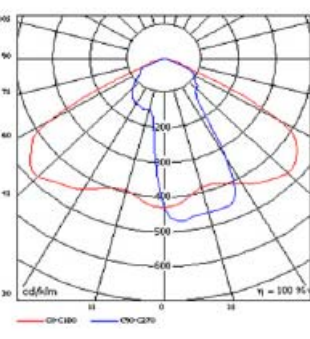
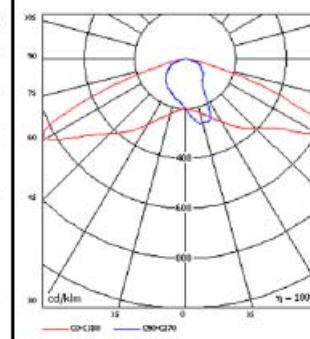

Everlight Dolphin Street Light Illumination Characteristics

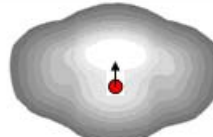
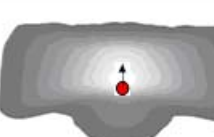
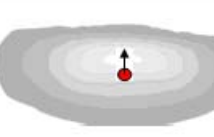
Intensity Distribution Curve Choice			
Light Engine Type	SL-Phoenix series	SL-Trex series	SL-Venus series
Intensity Distribution Curve			
Application	 TYPE II Parking and roadway. Asymmetric wide for parking and road way applications. High Uniformity.	 TYPE II Roadway lighting. Asymmetric short for streets, pedestrian walkways. High Brightness.	 TYPE III Parking and roadway. Asymmetric wide and long for parking and road way applications
Height of Pole	6-8m	8-10m	6-8m
Width of Road	<12m	<12m	<8m
Light Pattern @8m Height			



EVERLIGHT AMERICAS, INC.

**Light Pattern for SL-Dolphin/100240AC/Ph120@ 8m Height
(For reference only)**

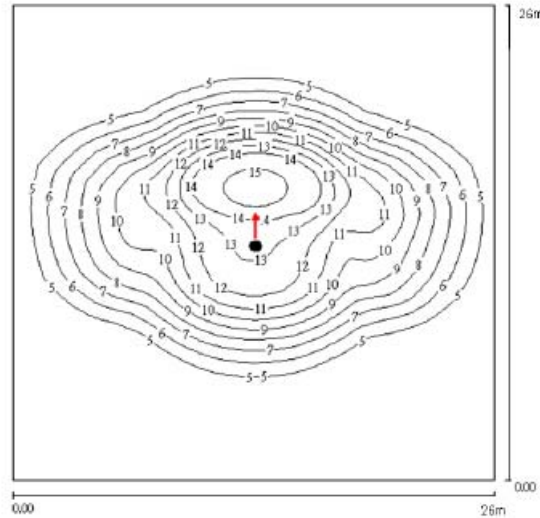

**Light Pattern for SL-Dolphin/100240AC/Tr120@ 8m Height
(For reference only)**

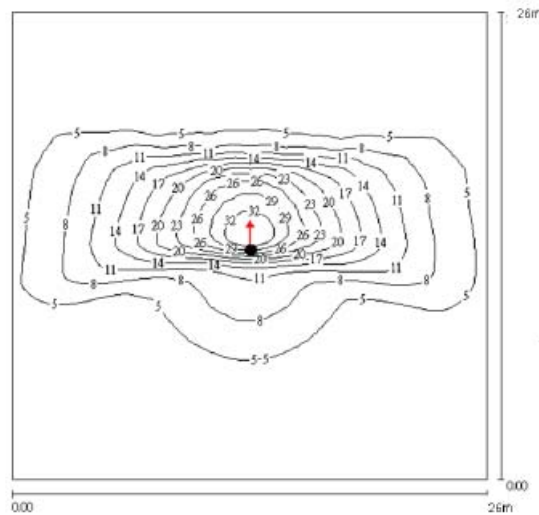

Everlight Americas, Inc.

3220 Commander Drive, Suite 100, Carrollton, Texas 75006

Device No. : DMM-0000069

<http://www.everlightamericas.com/>

Prepared date: 04-23-2009

Rev. 3 Page: 8 of 11

(972) – 490 – 4008

Prepared by: Felix Tsai



EVERLIGHT AMERICAS, INC.

Light Pattern for SL-Dolphin/100240AC/Ve120@ 8m Height (For reference only)

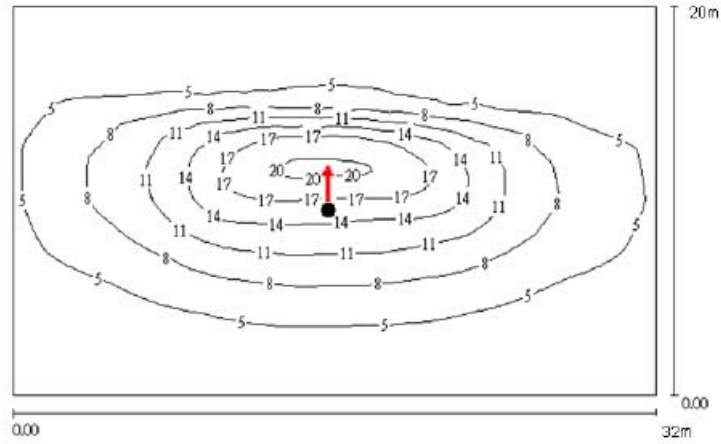

Everlight Americas, Inc.
3220 Commander Drive, Suite 100, Carrollton, Texas 75006
Device No. : DMM-0000069

<http://www.everlightamericas.com/>
Prepared date: 04-23-2009

Rev. 3 Page: 9 of 11
(972) – 490 – 4008
Prepared by: Felix Tsai



EVERLIGHT AMERICAS, INC.

Carrier Specifications :

1. Carton size: 770(L) x 420(W) x 180(H) mm
2. Overall weight:~12 Kg (with package)



Everlight Americas, Inc.
3220 Commander Drive, Suite 100, Carrollton, Texas 75006
Device No. : DMM-0000069

<http://www.everlightamericas.com/>
Prepared date: 04-23-2009

Rev. 3 Page: 10 of 11
(972) – 490 – 4008
Prepared by: Felix Tsai



EVERLIGHT AMERICAS, INC.

Label Explanation

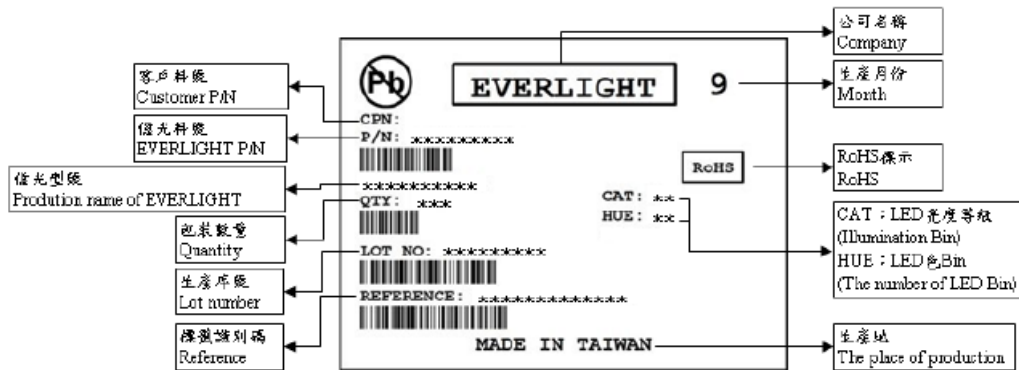
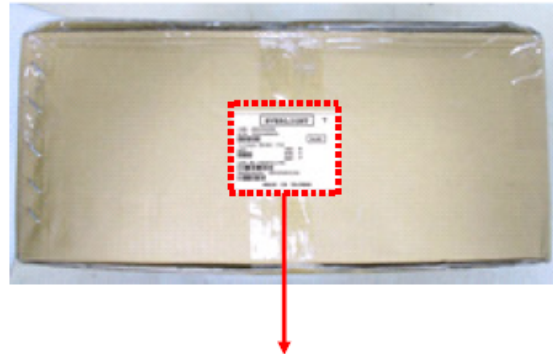

Note:

1. Since we are continuously improving all our products, the information listed in this document, which includes specifications, characteristics, data, materials used, structure, etc., are subject to change. It is necessary that you request the newest specification sheet from Everlight when you place any inquiry or purchase an order.
2. Before installing, please refer to the separate document, "Installation Instructions".

American Electric Lighting 115 HPS (115-15-S-MR-240-R2-FG-DF-HP-UL)

Street Light Specification/Data Sheets

Roadway Series 115

Roadway Lighting

50-400W HPS, 70-250W MH

PRODUCT OVERVIEW



Features:

Rugged die-cast aluminum housing is powder-coated for durability and corrosion resistance

Two-bolt mast arm mount provides easy, secure installation and adjustability for arms from 1-1/4" to 2" (1-5/8" to 2-3/8" O.D.) diameter. Optional four-bolt mounting provides extra security in high-vibration applications

Die-cast trigger latch on doorframe enables easy and secure one-hand opening for re-lamping and maintenance

Large surface area "breathing seal" gasket seals the optical chamber to prevent intrusion by insects and environmental contaminants. Heat-resistant gasket material remains effective over the life of the fixture

Wildlife shield is cast into the housing (not a separate piece) on the two-bolt unit and is easily adjustable for 1-1/4" to 2" (1-5/8" to 2-3/8" O.D.) mast arms

Photocontrol receptacle is adjustable without tools

Anodized aluminum reflectors provide uniform lighting distribution with borosilicate glass, acrylic, or polycarbonate refractor

Surge protection device (standard with ELBD models) exceeds IEEE/ANSI C62.41 Category C criteria

New DTL photocontrol for solid-state lighting (available with PCSS option) exceeds ANSI C136.10 criteria

NEMA wattage label, terminal block, and NEMA photocontrol receptacle are standard

All electrical components warranted by American Electric Lighting's 6-year guarantee

E39 mogul base socket standard

Suitable for -30°C MH / -40°C HPS

Complies with ANSI: C136.2, C136.10, C136.14, C136.15, C136.17, C136.31

Applications:

- Roadways
- Residential streets
- Storage areas
- Parking lots
- Campuses
- Parks

DIMENSIONS

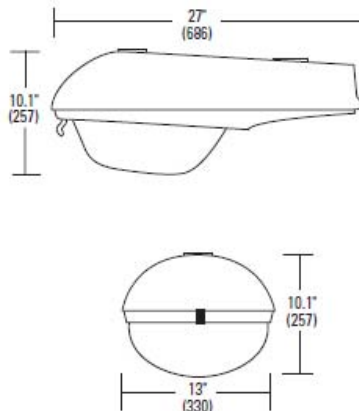

Effective Projected Area (EPA)
The EPA for the Horizontal Luminaire Series 115 is 0.9 sq. ft.
Approx. Wt. = 19 lbs.

PREFERRED SELECTION CATALOG NUMBERS

- 115 10S RN 120 R2 DA
- 115 15S CA MT1 R2 DA EC
- 115 15S RH 120 R2 DA
- 115 25S CA MT1 R3 DG EC

Roadway Series 115

Roadway Lighting

50-400W HPS, 70-250W MH

ORDERING INFORMATION

Example: 115 15S RN 120 R2 DG LC PC

Series	Wattage / Source	Ballast	Voltage	Distribution
115 Single Door Cobrahead	05 50W S HPS	RN Reactor Normal Power Factor	120 120V	R2 Roadway Type II
	07 70W M MH ²	RH Reactor High Power Factor	208 208V	R3 Roadway Type III
	10 100W	XN High Reactance (Lag) Normal Power Factor	240 240V	RX Roadway Type II 4-way ⁴
	13 100/150W Wired 100W	XH High Reactance (Lag) High Power Factor	277 277V	Refer to optic distribution matrix below for compatibility.
	14 100/150W Wired 150W	CA CWA ²	347 347V	
	15 150W	CT CWI	480 480V	Optics
	17 175W ¹	SC SCWA	MT1 Multi-tap Wired 120V	
	20 200W	MR Mag Reg (3 Coil)	MT8 Multi-tap Wired 208V	DA Drop Acrylic Prismatic Refractor ⁵
	25 250W ¹	ELBD Electronic Ballast/Driver ³	MT2 Multi-tap Wired 240V	DP Drop Polycarbonate Prismatic Refractor
	40 400W		MT7 Multi-tap Wired 277V	DG Drop Glass Prismatic Refractor

See ballast matrix for EISA compliant options

Options	
Mounting	Photocontrol Receptacle
(blank) 2-bolt Internal	(blank) NEMA Photocontrol Receptacle (standard)
EF External Fitter (2-bolt only)	NR No Photocontrol Receptacle ⁹
4B 4-bolt Internal	
M2 2-bolt Internal 2" Setting	Lamp
E2 External Fitter 2" Mast Arm (2-bolt only)	LC Lamp Included, Clear
	LD Lamp Included, Deluxe/Coated
Paint ⁶	Starter ⁵
(blank) Gray (standard)	(blank) Open Board (standard)
BK Black	EC Encapsulated Plug-in
BZ Bronze	OP Open Plug-in
DDB Dark Bronze	
WH White	Misc.
UP Unpainted	PC Photocontrol Included per Voltage Specified ⁹
Terminal Block	PCSS Solid-State Lighting Photocontrol (120-277V) ⁹
(blank) Terminal Block (standard)	BL Bubble Level
T2 Wired to L1 to L2 Position	SS Stainless Steel Fasteners (external)
T3 3 Wire Operation (L1, N, L2 Position) ⁷	CF Charcoal Filter
Listing	PL Distribution Pattern
UL UL Listed	LA Lightning Arrestor (Void UL/CSA Certified Options)
CS CSA Certified	SH Shorting Cap ⁹
Fusing ⁸	HK Hinge Keeper
SF Single Fuse (120, 277, 347V)	BF 3G Vibration ¹⁰
DF Double Fuse (208, 220, 240, 480V)	RG Rubber Silicone Optical Gasket

Notes:

- When ordered with metal halide, these wattages do not comply with California Title 20 regulations
- CA ballast not available with 175W - 400W metal halide in the U.S.; must use SC
- 100 and 150W HPS and 150W MH only; 150W HPS requires S56 lamp
- DG option only
- For HPS products only
- Other colors available, please contact your local American Electric Lighting representative
- T3 option only available with 240, 480, DT2, DT4, MT2
- Not available in MT, TT, DT voltages
- PC, PCSS and SH not available with NR option
- Tested to withstand 3G vibration; 4B option required

Optic Distribution

	R2 DA	R3 DA	R2 DP	R3 DP	R2 DG	R3 DG	RX DG
05S	◆	◆	◆	◆	◆	◆	◆
07S	◆	◆	◆	◆	◆	◆	◆
07M	-	-	◆	-	◆	-	◆
10S	◆	◆	◆	◆	◆	◆	◆
10M	-	-	◆	-	◆	-	◆
15S	◆	◆	◆	◆	◆	◆	◆
13S	◆	◆	◆	◆	◆	◆	◆
14S	◆	◆	◆	◆	◆	◆	◆
15M	-	-	◆	-	◆	-	◆
17M	-	-	◆	◆	◆	◆	◆
20S	-	-	◆	◆	◆	◆	◆
25S	-	-	◆	◆	◆	◆	◆
25M	-	-	◆	◆	◆	◆	◆
40S	-	-	-	-	◆	◆	◆



© 2009 Acuity Brands Lighting, Inc. All rights reserved. Rev. 2/10

Sheet # RW-115-A

American Electric Lighting
Acuity Brands Lighting, Inc.
3825 Columbus Rd. S.W., Granville, OH 43023
Phone: 800-754-0463 Fax: 740-587-6114
www.americanelectriclighting.com

Roadway Series 115

Roadway Lighting

50-400W HPS, 70-250W MH

BALLAST MATRIX

Roadway 115

Watts	120	200	240	277	347	400	DT2	DT4
05S	RH,RH	-	-	XN	-	-	-	-
07S	CA,CT,RH,RN	XN,XH,CA,CT	XN,XH,CA,CT	XN,XH,CA	XH,XN	CA	XN,XH,CA,CT	-
07M	XN,XH	XN,XH	XN,XH	XN,XH	-	-	-	-
10S	CA,CT,ELBD,MR,RH,RN	CA,CT,ELBD,XN,XH	CA,CT,ELBD,MR,XH,XN	CA,ELBD,XH,XN	-	CA	CA,CT,MR,XH,XN	-
10M	XN,XH	XN,XH	XN,XH	XN,XH	-	-	-	-
15S	CA,CT,ELBD,MR,RH,RN	CA,CT,ELBD,XN,XH	CA,CT,ELBD,MR,XH,XN	XN,XH,ELBD,CA,CT	XH,XN	CA,MR,XN,XH	CA,CT,MR,XH,XN	-
13S	RH,RH	-	-	-	-	-	-	-
14S	RH,RH	-	-	-	-	-	-	-
15M	XN,XH,ELBD	XN,XH,ELBD	XN,XH,ELBD	XN,XH,ELBD	-	-	-	-
17M	SC	SC	SC	SC	SC	SC	SC	SC
20S	CA,CT,XN,XH	CA,CT	CA,CT,RH,RH,XN,XH	CA,CT	-	CA,CT	CA,CT,XN,XH	MR
25S	CA,CT,XN,XH	CA,CT	CA,CT,RH,RH,XN,XH	CA,CT	-	CA,CT	CA,CT,XN,XH	MR
25M	SC	SC	SC	SC	SC	SC	SC	SC
40S	-	RH,RH	RH,RH	-	-	-	-	-

Roadway 115 continued

Watts	MT1	MT2	MT7	TTS
05S	-	-	-	-
07S	CA,XH,XN	CA,XH,XN	CA,XH,XN	XH,XN
07M	-	-	-	-
10S	CA,CT,XH,XN	CA,CT,XH,XN	CA,CT,XN,XH	-
10M	XH,XN	XH,XN	XH,XN	-
15S	CA,CT,XH,XN	CA,CT,XH,XN	CA,CT,XH,XN	XH,XN
13S	-	-	-	-
14S	-	-	-	-
15M	-	-	-	XH,XN
17M	SC	SC	SC	-
20S	CA,CT	CA,CT	CA,CT	-
25S	CA,CT	CA,CT	CA,CT	CA
25M	SC	SC	SC	SC
40S	-	-	-	-

PHOTOMETRICS

115 15S R3 DA

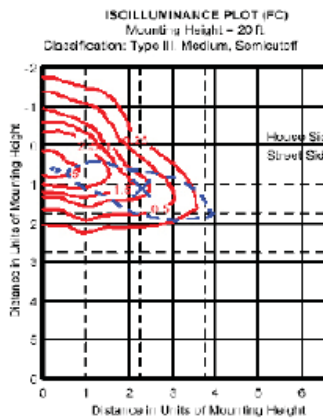

115 25S R3 DG

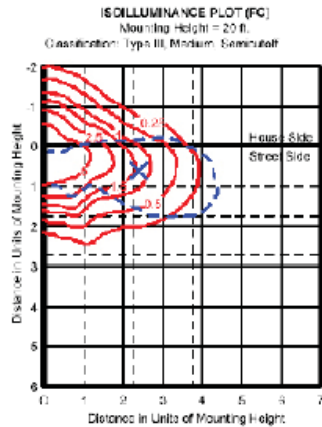

115 15S R2 DP

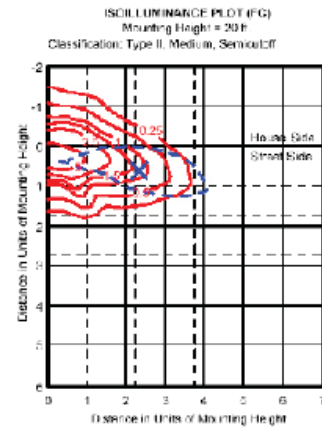

X Maximum Intensity
--- 1/2 Maximum Intensity

General Electric M-400A HPS (MDCL-25-S-3-A-1-2-F-MC3-2-FU) Street Light Specification/Data Sheets

M-400A POWR/DOOR® LUMINAIRE WITH CUTOFF OPTICS



APPLICATIONS

- For street, highway and parking lot lighting

SPECIFICATION FEATURES

- Powr/Module ballast assembly
- Filtered optics
- Universal two or four-bolt slipfitter
- Standardized reflector
- "Dead back" tunnel type, FRP terminal board
- 2 in. pipe mounting only with MDCA
- Die-cast aluminum housing with polyester powder gray paint finish
- Adjustable mogul base socket (house side) - E39 standard
- ALGLAS® finish on reflector
- No-tool PE receptacle
- Plug-in ignitor available
- External paddle type stainless steel bail latch
- @/® listed unit available—See Options
- True 90° cutoff—no light above 90° (meets RP8-2000 for full cutoff) with flat glass

ORDERING NUMBER LOGIC

MDCL	W	S	V	A	PE	I	F	MC3	1	F
PRODUCT IDENT	WATTAGE	LIGHT SOURCE	VOLTAGE	BALLAST TYPE	FUNCTION	IGNITOR MOUNTING	LENS TYPE	IES DISTRIBUTION TYPE	FILTER	OPTIONS
XXXX	XX	X	X	X	X	X	X	XXXX	X	XXX
MDCA = M-400A with Cutoff * 4-Bolt Slipfitter	10 = 100 15 = 150 (55V) 17 = 175 20 = 200 24 = 250/400 25 = 250 31 = 310 32 = 320 35 = 350 40 = 400	E = Energy Act Compliant Pulse MH (EPMH) S = HPS P = PMH Standards Lamp not included.	60Hz 0 = 120/208/240/277 Multivolt 1 = 120 2 = 208 3 = 240 4 = 277 5 = 480 7 = 120X240 8 = 240V Ballast 120V PE Receptacle not re-connectable D = 347 F = 120X347 T = 220 W = 230 50Hz 6 = 220 R = 230 Y = 240 NOTE: Dual voltage connected for lower voltage	See Ballast Selection Table A = Autoreg H = HPF Reactor or Lag M = Mag-reg N = NPF Reactor or Lag P = CWI with Grounded Socket Shell	1 = None 2 = PE Receptacle NOTE: Receptacle connected same voltage as unit except as noted. Order PE Control separately.	1 = Non Plug-in/ None 2 = Plug-in base and ignitor	A = Acrylic Clear Globe (250 watt Maximum) F = Flat Glass * G = Shallow Glass Globe L = Polycarbonate Clear Globe (250 watt) HPS only * = Previously IESNA Full Cutoff Optics	See Photometric Selection Table S = Short M = Medium C = Cutoff * 1 = Type I 2 = Type II 3 = Type III * = Previously IESNA Full Cutoff Optics	1 = Fiber gasket 2 = Charcoal with elastomer gasket	F = Fusing (Not available with multivolt or dual voltage) J = Line Surge Protector, Expulsion Type N = Meets ANSI C136.31 requirements for Bridge and Underpass Vibration U = UL Listed Glass Lens and (60Hz only)



PHOTOMETRIC SELECTION TABLE

CLEAR REFRACTORS All light sources are clear.

Wattage	Light Source	IES Distribution Type Photometric Curve Number 35-45XXXX							
		Flat Glass "F"				SAG Glass Globe "G"			
		MC2	MC3	MC1	SC2	SC3	MC2	MC3	
150 (55V)	HPS	0386	0387	N/A	N/A	N/A	0547	0546	C/F
200-400	HPS	1001	1002	N/A	0101	0102	1003	1004	1045** (MC3)
175, 250, 320, 350, 400	EPMH	0343	0342	N/A	N/A	N/A	0544	0545	C/F
	EPMH	*452880	*452882	0281	N/A	N/A	0280	N/A	N/A

NOTE: N/A = Not Available C/F = Contact Factory
PMH—Contact Factory
*Requires the use of ED-28 Lamp
**250 watts maximum

GE Lighting Systems, Inc.
www.gelighting.com

**M-400A POWR/DOOR® LUMINAIRE
WITH CUTOFF OPTICS & 4 BOLT SLIPFITTER**

FIXTURE DIMENSIONS

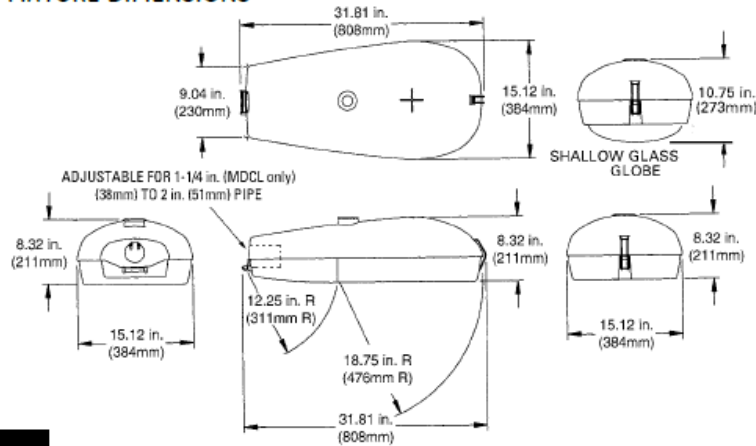

DATA

Approximate Net Weight	33-39 lbs	15-19 kgs
Effective Projected Area	1.1 sq. ft. max	.01 sq. M max
Suggested Mounting Height	30-50 ft.	9-15 M

REFERENCES

See Page R-48 for start of Accessories.
See Page R-52 for Explanation of Options and Other Terms Used.
See Pole and Bracket Section Page P-2 for pole selection.

BALLAST SELECTION TABLE

Wattage	Light Source	Multi-volt	Ballast Type/Voltage														
			60Hz									50Hz					
			120	208	240	277	480	120X 240	347, 120X347	240/120 PE R	220	230	220	230	240		
150 (55V)	HPS	H,N,A	G,H,M,N	G,M	G,M	G,M	G,M	G,M	G,M	G,H,M,N	G*,H,M*,N	G,M	N/A	N/A	N/A	N/A	N/A
200	HPS	A,M,P	A,G,H,M,N,P	A,G,H,M,N,P	A,G,H,M,N,P	A,G,M,P	A,G,M	A,G,M	A,G,M	A,G,M,P	N/A	A,G,H,M,N	N/A	H	N/A	N/A	N/A
250	HPS	A,M,P	A,G,H,M,N,P	A,G,H,M,N,P	A,G,H,M,N,P	A,G,M,P	A,G,M	A,G,M	A,G,M	A,G,M,P	A,M,P	A,G,H,M,N	A,H	H	A,H,M,N	H	M
250/400	HPS	A	A	A	A	A	A	A	A	N/A	N/A	N/A	N/A	N/A	N/A	N/A	N/A
310	HPS	A,M	A,G,M	A,G,H,M,N	A,G,H,M,N	A,G,M	A,G,M	A,G,M	A,G,M	A,G,M	N/A	A,G,H,M,N	N/A	H	N/A	N/A	N/A
400	HPS	A,M	A,G,M	A,G,H,M,N	A,G,H,M,N	A,G,M	A,G,M	A,G,M	A,G,M	A,G,M	A,G,M	A,G,H,M,N	H,A,N	H	A,H,M,N	N/A	A,H,M
175	EPMH	A	A	A	A	A	A	A	A	A	N/A	A	N/A	N/A	N/A	N/A	N/A
250	EPMH	A	A	A	A	A	A	A	A	A	N/A	A	N/A	N/A	N/A	N/A	N/A
320	EPMH	A	A	A	A	A	A	N/A	A	A	N/A	A	N/A	N/A	N/A	N/A	N/A
350	EPMH	A	A	A	A	A	A	N/A	A	A	N/A	A	N/A	N/A	N/A	N/A	N/A
400	EPMH	A	A	A	A	A	A	N/A	A	A	N/A	A	N/A	N/A	N/A	N/A	N/A

NOTE: N/A = Not Available
*Not available in 120X347 volt
C/F = Contact factory

MDCA — SUGGESTED CATALOG ORDERING NUMBERS

Catalog Number	Wattage	Light Source	Voltage (60 Hz)	Ballast Type	Refractor Type	Photometric Distribution
MDCA25S0A22FMC21	250	HPS	Multivolt	Auto-Regulator	Glass	MC2
MDCA40S0A22FMC31	400	HPS	Multivolt	Auto-Regulator	Glass	MC3

All GE suggested catalog ordering numbers come with PE receptacle. PE control must be ordered separately. Order and install SCCL-PECTL if no PE is desired.

Multivolt ballasts can be for either 120, 208, 240, or 277 volt incoming power supply.

GE Lighting Systems, Inc.
www.gelighting.com

2008/R-15



Extech HD450 Light Meter Product Data Sheets

EXTECH
INSTRUMENTS
A FLIR COMPANY

Experience the **Extech Advantage**
PRODUCT DATASHEET

Heavy Duty Light Meters

Datalogging Model Available
Automatically stores up to 16,000 readings or manually store/recall up to 99 readings.

Features:

- HD450 Datalogger model automatically stores up to 16,000 readings or manually store/recall up to 99 readings
- Wide range to 40,000Fc or 400,000 Lux
- Cosine and color corrected measurements
- Utilizes precision silicon photo diode and spectral response filter
- Peak mode (10µs) captures highest reading
- Relative mode indicates change in light levels
- Min/Max and Data Hold
- Large backlit LCD display with 40-segment bar graph
- Heavy Duty rugged double molded housing
- Built-in USB port
- Includes light sensor with 3ft (1m) cable and protective cover, Windows® compatible software with USB cable, hard carrying case, and 9V battery



Ordering Information:

HD400Heavy Duty Light Meter
 HD400-NIST ..Heavy Duty Light Meter with NIST Certificate
 HD450Heavy Duty Datalogging Light Meter
 HD450-NIST ..Heavy Duty Datalogging Light Meter with NIST Certificate
 TR100Tripod for meters with tripod mount feature

Specifications	
Fc Range	40, 400, 4000, 40.00kFc
Lux Range	400, 4000, 40k, 400kLux
Accuracy	±5% rdg
Max Resolution	0.01Fc/0.1Lux
Datalogging	16,000 continuous readings; 99 selected readings
PC interface	USB
Dimensions	6.7 x 3.1 x 1.6" (170 x 80 x 40mm)
Weight	13.7oz (390g)

CE

www.extech.com

Specifications subject to change without notice. Copyright © 2008 Extech Instruments Corporation. All rights reserved including the right of reproduction in whole or in part in any form. 101308 - R1

Fluke 43B Power Quality Analyzer Specification/Data Sheet



Fluke 43B Power Quality Analyzer

Maintain power systems, troubleshoot power problems, diagnose equipment failures



The Fluke 43B Power Quality Analyzer performs the measurements you need to maintain power systems, troubleshoot power problems and diagnose equipment failures. All in a rugged handheld package.

- **New!** NiMH Battery provides extended operating time of 6.5 hours
- Combines the most useful capabilities of a power quality analyzer, multimeter and scope
- Calculates 3-phase power on balanced loads, from a single-phase measurement
- Trends voltage, current, frequency, power harmonics and captures voltage sags, transients and inrush current
- Monitoring functions help track intermittent problems and power system performance
- Records two selectable parameters for up to 16 days
- 20 measurement memories to save/recall screens and data with cursor readings
- FlukeView® Software can log harmonics and all other readings over time and provides a complete harmonics profile up to the 51st harmonic
- Measures resistance, diode voltage drop, continuity, and capacitance
- Users/applications manual and power quality video to help answer tough questions
- Complete package with voltage probes and 400 A current clamp, FlukeView Software and optically isolated interface cable
- 3 year warranty on the Fluke 43B, 1 year on accessories

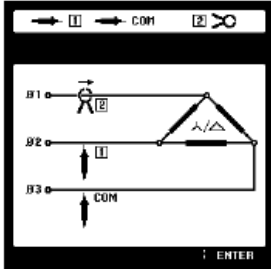

On screen graphics show you how to set up 3-phase power measurements

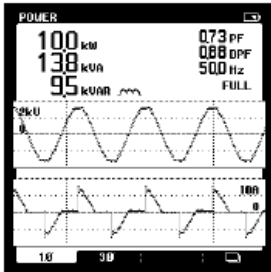

Watts, power factor, displacement power factor (Cos φ), VA and VAR
Voltage and current waveforms



Voltage and current waveforms
True-rms voltage and current
Frequency

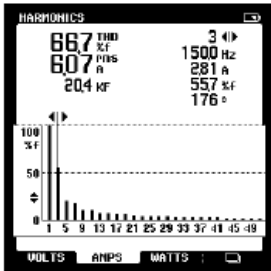

Voltage, current, and power harmonics
Up to 51st harmonic
Total harmonic distortion (THD)
Phase angle of individual harmonics

Specifications

Accuracies are stated as ± (percentage of reading + counts) without probes unless otherwise noted.

Specifications are valid for signals with a fundamental between 40 and 70 Hz.

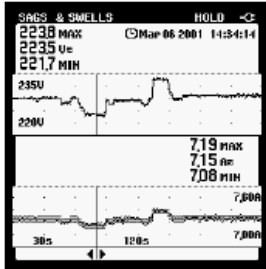

- Measurements are always automatically recorded to instantly show changes over time
- Use cursors to read time and date of sags and swells

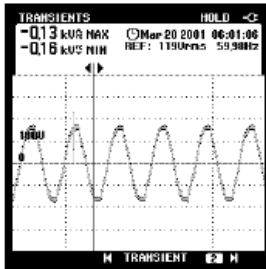

- Catch voltage transients and waveform distortion down to 40 nS
- Catch and save up to 40 transients
- Correlate the cause of transients with time and date stamps

Input Characteristics	Ranges	Accuracy
Input impedance	1 MΩ, 20 pF	
Voltage rating	600 Vrms, CAT III	
Volt/Amps/Hz		
True-rms voltage (AC+DC)	5.000 V, 50.00 V, 500.0 V, 1250 V*	± (1 % + 10 counts)
True-rms current (AC+DC)	50.00 A, 500.0 A, 5.000 kA, 50.00 kA, 1250 kA	± (1 % + 10 counts)
Frequency	10.0 Hz to 15.0 kHz	± (0.5 % + 2 counts)
CF Crest Factor	1.0 to 10.0	± (5 % + 1 count)
Power		
W, VA, VAR Reactive Power 1-phase and 3-phase, 3 conductor balanced loads	250 W 2.50 kW, 25.0 kW, 250kW, 2.50 MW, 25 MW, 250 MW, 625 MW, 1.56 GW	± (2 % + 6 counts) Total Power ± (4 % + 4 counts) Fundamental Power
PF Power Factor	0.00 to 1.00	± 0.04
DPF Displacement Power Factor	0.00 to 0.25 0.25 to 0.90 0.90 to 1.00	not specified ± 0.04 ± 0.03
Hz Frequency fundamental	40.0 to 70.0 Hz	± (0.5 % + 2 counts)
Harmonics		
Volts, Amps, Watts	Fundamental	V, A ± (3 % + 2 counts), W ± (5 % + 2 counts)
	2 to 31st Harmonic	V, A ± (5 % + 3 counts), W ± (10 % + 10 counts)
	32 to 51st Harmonic	V, A ± (15 % + 5 counts), W ± (30 % + 5 counts)
Frequency of fundamental	40 Hz to 70 Hz	± 0.25 Hz
Phase	Volt & Amps (between Fund. & Harmonic)	2nd (± 3°) ... 51st (± 15°)
	Watts (between Volt Fund. & Amps Harmonic)	Fund (± 5°) ... 51st (± 15°)
K-Factor (Amps & Watts)	1.0 to 30.0	± 10 %
THD	0.00 to 99.99	± (3% + 8 counts)
Sags & Swells		
Recording times (selectable)	4 min to 16 days	
Vrms actual, Vrms max, min (AC + DC)	5.000 V, 50.00 V 500.0 V, 1250 V*	Readings ± (2 % + 10 counts) Cursor readings ± (2 % + 12 counts) Cursor Readings Average ± (2 % + 10 counts)
Arms actual, Arms max, min (AC + DC)	50.00 A, 500.0 A, 5.000 kA, 50.00 kA	
Recording		
Recording times (selectable)	4 min to 16 days	
Parameters	Choose one or two parameters from one of the groups below	
V/A/Hz	Line Voltage, Current, Frequency	
Power	Watts, VA, VAR, PF, DPF, Frequency	
Harmonics	THD, Volts (Fund. & Harmonic), Amps(F&H) Watts(F&H) Freq.(H), %(H) of total, Phase(H), KP	
Ohms	Ohms, Diode, Continuity, Capacitance	
Temperature	°C or °F	
Scope	DC Voltage, DC Current, AC Voltage, AC Current, Frequency, Pulse Width + or -, Phase, Duty cycle + or -, Peak max, Peak min, Peak min-max, Crest Factor	
Transients		
Minimum pulse width	40 ns	
Useful bandwidth input	DC to 1 MHz (with test leads TL24)	
Number of transients	40	
Voltage threshold settings	20 %, 50 %, 100 %, 200 % above or below reference signal	
Reference signal	After START, the Vrms and frequency of the signal are measured. From these data a pure sinewave is calculated as reference for threshold setting.	
Vpeak min, Vpeak max at cursor	10 V, 25 V, 50 V, 125 V, 250 V, 500 V, 1250 V	
	± 5 % of full scale	

*Rated 600 V CAT II

Inrush Current	Ranges	Accuracy
Current ranges (selectable)	1 A, 5 A, 10 A, 50 A, 100 A, 500 A, 1000 A	
Inrush times (selectable)	1 s, 5 s, 10 s, 50 s, 100 s, 5 min	
Cursor readings	A peak max at cursor 1 and cursor 2	± 5 % of full scale
Time between cursors**	4 to 235 pixels	± (0.2 % + 2 pixels)
Scope, dual channel scope with measurement reading		
Input impedance		
Input 1	1 MΩ/12 pF, with BB120: 20 pF	± 2 pF, with BB120 ± 3 pF
Input 2	1 MΩ/10 pF, with BB120: 18 pF	± 2 pF, with BB120 ± 3 pF
Vertical		
Voltage ranges	50 mV/div to 500V/div	± (1% + 2 pixels)
Vertical sensitivity, resolution	5 mV/div to 500V/div, 8 bit (256 levels)	
Bandwidth Input 1 (voltage)	DC to 20 MHz at inputs, or with VPS40 probe (Opt); 1 MHz with TL24 Leads	
Bandwidth Input 2 (current)	DC to 15 kHz at inputs 10 kHz with 901-500s Current Clamp	
Coupling	DC, AC (10Hz ±3 dB)	
Horizontal		
TimeBase modes	Normal, roll, single	
TimeBase ranges	60 s/div to 20 ns/div	± (0.4 % + 1 pixel)
Sampling rate	25 MS/s	
Record length (min / max samples)	512 per channel	
Trigger source	Input 1 or Input 2 or Automatic selection	
Trigger mode	Automatic Connect-and-View™, Free Run, Single Shot.	
Connect-and-View™	Advanced automatic triggering that recognizes signal patterns and automatically adjusts triggering, timebase and amplitude. Automatically displays stable pictures of complex and dynamic signals like motor drive and control signals.	
Pre-trigger	Up to 10 divisions	
Measurement readings, per channel selectable	Volts & Amps (DC, AC, AC + DCrms, Peak max, Peak min, Peak min / max), Frequency, Duty cycle + or - , Phase, Pulse Width + or - , Crest factor	
Ohms, Diode, Continuity, Capacitance		
Ohms	500.0 Ω, 5.000 kΩ, 50.00 kΩ, 500.0 kΩ, 5.000 MΩ, 30.00 MΩ	± (0.6 % + 8 counts)
Diode voltage	0 to 3,000 V	± (2 % + 5 counts)
Continuity, shorts > 1 ms	Beeper on at < 30 Ω ± 5 Ω.	
Capacitance	50.00 nF, 500.0 nF, 5.000 μF, 50.00 μF, 500.0 μF	±(2 % + 10 counts)
Temperature***	-100.0 °C to 400.0 °C, -200.0 °F to 800.0 °F	±(0.5 % + 5 counts)
Max current, max open circuit volt.	0.5 mA, < 4 V (all functions above)	
Memory		
Number of screens	20	
Optical Isolated Interface		
To printer	Supports HP LaserJet™, DeskJet, Epson FX/LQ and Postscript printers with optional PAC91 Printer Adapter Cable	
To PC	FlukeView® Power Quality Analyzer software with PM9080 Interface Adapter included	
FlukeView® Power Quality Software		
Hardware requirements	PC or 100 % compatible with Windows® 95, 98, Me, 2000, NT4.0.	

** 1 pixel = Inrush time/250

*** Requires optional temperature accessory

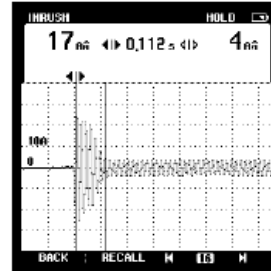

- Inrush current up to 500A with supplied current probe
- Use cursors to measure inrush current timing

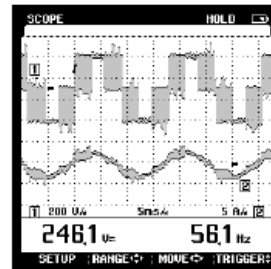

- Connect-and-View™ scope for quick waveform display
- 20MHz bandwidth with optional 10:1 voltage probe. 15kHz on current channel with optional current clamp

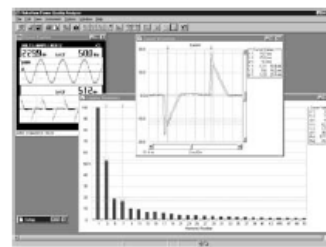

- FlukeView® Power Quality Analyzer software (included)
- Capture measurement screens for professional-looking reports
- Log readings to your computer disk drive
- Works with Windows word processing, spreadsheet and analysis software
- Windows 95 / 98 / Me / 2000 / NT 4.0

General Specifications

Power	
Line voltage adapter/battery charger included	
Installed battery	Rechargeable NiMH pack (4.8v dc)
Operating time	4 hours
Charging time	7 hours
Environmental	
Temperature	0 °C to 50 °C (32 °F to 122 °F)
Environmental	MIL 28800E, Type 3, Class III, Style B
Enclosure	IP51 (dust, drip water proof)
Mechanical Data	
Size (H x W x D)	232 x 115 x 50 mm (9.1 x 4.5 x 2 inches)
Weight	1.1 kg (2.5 lbs.) incl. battery pack
Safety	
For measurements on 600 Vrms Category III installations, Pollution Degree 2 in accordance with EN 61010-1 ANSI/ISA S82.01-1994 CAN/CSA-C22.2 No. 61010.1-04	
Surge protection	6 kV on Input 1 and 2
Floating measurements	600 Vrms from any terminal to ground
Warranty	3 years parts and labor on Fluke 43B, 1 year on accessories

Ordering Information

Fluke 43B Power Quality Analyzer

Included Accessories

C120	Hard Case
TL24	Test Leads
AC20	Industrial Test Clips
AC85	Large Jaw Alligator Clips
TP1	Flat-tipped Slim-Reach™ Test Probes
TP4	4 mm Round Slim-Reach™ Test Probes
i400s	400 A AC Current Clamp
OC4USB	Optically Isolated USB Interface Adapter
BP120MH	Rechargeable NiMH Battery Pack (installed)
PM8907	Line Voltage Adapter/Battery Charger
SW43W	FlukeView® Power Quality Analyzer Software for Windows

Power Quality CD with:

- User's manual
- Power quality video
- Application guide

Getting started guide

Shielded Banana-to-BNC adapter

Optional Accessories

C789	Soft Carrying Case
80i-110s	100A AC/DC Current Probe
i200s	AC Current Clamp
i1000s	1000A AC Current Clamp
i2000flex	Flexible 2000A AC Current Probe
i3000s	Clamp-On AC Current Clamp
VPS40	10:1 Voltage Probe
BB120	Two Shielded Banana-to-BNC Adapters
80TK	Thermocouple Module
80T-150U	Universal Temperature Probe
PAC91	Parallel Printer Adapter
TLK225	SureGrip® Master Accessory Test Lead Kit
TL220	63" Test Lead Set
TL221	Extension Lead Set
TL223	Electrical Test Lead Set



Fluke. Keeping your world up and running.

Fluke Corporation

PO Box 9090, Everett, WA USA 98206

Fluke Europe B.V.
PO Box 1186, 5602 BD
Eindhoven, The Netherlands

For more information call:
In the U.S.A. (800) 443-5853 or
Fax (425) 446-5116
In Europe/M-East/Africa (31 40) 2 675 200 or
Fax (31 40) 2 675 222
In Canada (800) 36-FLUKE or
Fax (905) 890-6866
From other countries (425) 446-5500 or
Fax (425) 446-5116
Web access: <http://www.fluke.com/>

©2005 Fluke Corporation. All rights reserved.
Trademarks are the property of their respective owners.
Printed in U.S.A. 11/2005 1266142 D-ENG-N Rev H
Printed on recycled paper.



**MEASURES PHOTON
FLUX AND ENERGY FLUX
WITH HALF NANOMETER
BANDWIDTH RESOLUTION.**

DESCRIPTION

Our spectroradiometers are calibrated in a LI-COR LI1800-02 optical radiation calibrator. The lamp is a tungsten-halogen lamp and is NIST (National Institute of Standards and Technology) traceable and calibrated to a precise PPF Density ($\mu\text{mol m}^{-2} \text{s}^{-1}$) at LI-COR after every 50 hours of use.

All models come complete with components needed for portable use. The detector collects light for the spectroradiometer via fiber optic cable. The spectroradiometer then transmits its measurements to a PC where custom software (included) displays the spectrum of the light source. Live data can be saved as a data file suitable for work in other programs such as Excel or SigmaPlot.

Irradiance Measurements: Display in units of Watts per square meter (per nm) or Moles per square meter per second (per nm as a photon dose rate); simultaneous display of integrated PPF.

Illuminance Measurements: Display in units of Lumen per square meter (per nm) or footcandles as lumen per square foot; simultaneous display of integrated LUX.

CIELAB Application: Simultaneous window (with live spectra) displays 1931 CIE xy Chromaticity Diagram. Illuminance mode displays dominant wavelength and purity. Irradiance mode displays color temperature.



Spectrocolorimeter: Measures the color of reflected light. Simultaneous window (with live spectra) displays 1976 CIE LAB diagram for L^* , a^* , b^* . Display CIELAB color values with chroma, hue, x, y, and tristimulus and Delta-E*. Load or save standards for subsequent Delta-E* color comparisons.

Chemwiz Measurements: Measures the concentration of chemicals. Simultaneous window (with live spectra) allows concentration calibration or loading of previously developed chemicals to be loaded for concentration display of unknown samples. Performs single wavelength linear PLS calibrations.

UV Monitor: Measures the distribution of UV energy. Display in units of watts for UVA, UVB, UVC, ratio UVA/UVB, Vis/Ir power. Provides both maximum time in seconds until Erythema action and maximum time until Melanogenic action.

ORDERING INFORMATION

All products can be ordered at www.apogeeinstruments.com

For technical information contact techsupport@apogee-inst.com

SPECIFICATIONS

WAVELENGTH RANGE

- PS-100: 350 to 1000 nm
- PS-200: 300 to 850 nm
- PS-300: 300 to 1000 nm

BASE UNIT SIZE

- PS-100: 15.5 by 9.5 by 4 cm
- PS-200: 15.5 by 11 by 8 cm
- PS-300: 15.5 by 11 by 8 cm

BASE UNIT MASS

- PS-100: 500 g
- PS-200: 900 g
- PS-300: 900 g

DETECTOR

- 2048 pixel; 14 by 200 um microelement array

LINEAR RANGE

- 0 - 2.1 absorbance units (< 0.5%)

EXPOSURE RANGE

- 4 milliseconds to 60 seconds (synoptic multi-channel)

INTEGRATION TIME RANGE

- 4 to 6500 ms

INPUT POWER

- 220 - 250 mA at +5 VDC (provided)

OPTICAL CABLE

- 2 meters armored cable; cables are not interchangeable

WAVELENGTH RESOLUTION

- 0.5 nm

WAVELENGTH REPEATABILITY

- < 0.05 nm

WAVELENGTH STABILITY

- < 0.001 nm per °C

DYNAMIC RANGE

- 1 to 4096 counts ($\pm 0.5\%$)

SIGNAL TO NOISE RATIO

- Up to 1000:1

WARRANTY

- 1 year against defects in materials and workmanship

MEASUREMENTS

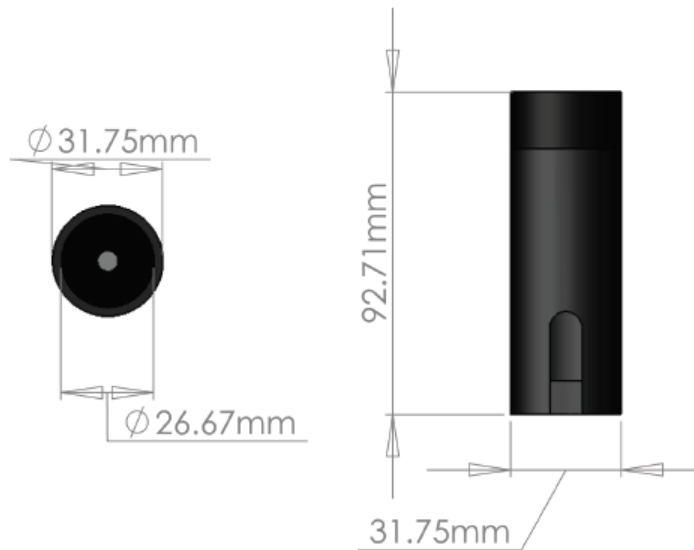

apogee
instruments inc.
www.apogeeinstruments.com

APPENDIX B: Tables I-X of a) Measured Illuminance at Floor Level b) Electrical Parameters, and c) Measured Illuminance Levels at 2, 4, and 6 Foot Heights on Measurement Grid

Table II: Beta 40 LED (Low Driver Setting) a) Floor Level Illuminance, b) Power Consumption, and c) Illuminance at 2, 4, & 6 Feet Heights on Measurement Grid

a)

Radial Distance (ft)	Illuminance Foot Candles (FC) Along Radial Lines at Given Angles												
	0	15	30	45	60	75	90	105	120	135	150	165	180
0	3.90	3.90	3.90	3.90	3.90	3.90	3.90	3.90	3.90	3.90	3.90	3.90	3.90
2	3.21	3.27	3.25	3.35	3.42	3.49	3.49	3.46	3.47	3.42	3.35	3.06	3.22
4	1.97	2.17	2.59	2.68	2.70	3.15	3.45	3.57	3.51	3.34	3.06	2.72	3.15
6	1.83	1.94	2.36	3.11	3.52	3.07	2.96	2.94	2.88	2.78	2.65	2.32	3.20
8	2.05	1.97	1.84	2.21	2.88	2.62	2.15	1.99	2.02	2.08	2.71	1.68	3.05
10	1.79	1.71	1.64	1.38	1.79	1.76	1.52	1.44	1.58	1.75	1.79	1.32	2.53
12				1.17	1.08	1.24	1.16	1.09	1.21	1.36	1.24	0.97	1.97
14				1.00	0.75	0.87	0.85	0.85	1.06	0.98	0.92	0.58	1.03
16					0.63	0.59	0.62	0.65	0.75	0.82	0.78	0.38	0.76
18					0.55	0.44	0.44	0.48	0.79	0.62	0.63	0.22	
20					0.49	0.34	0.30	0.39	0.64	0.51	0.35		
22					0.39	0.26	0.26	0.33	0.46	0.34	0.21		
24						0.22	0.24	0.26	0.32	0.26			
26						0.18	0.20	0.24	0.23	0.18			
28						0.15	0.18	0.20	0.18	0.13			
30						0.13	0.15	0.16	0.14				
32						0.12	0.13	0.14	0.12				
34						0.10	0.11	0.12	0.10				
36						0.08	0.09	0.10	0.08				
38						0.04	0.07	0.08	0.06				
40						0.04	0.06	0.07	0.04				
42									0.03				

b)

Electrical Parameters

	Voltage	Current	Frequency	Power	PF	DPF	%THD r
S: 2:45 PM	121	0.196	60	23	0.96	0.97	13.6
3:36 PM	121.1	0.194	60	22	0.95	0.97	13.8
E: 4:15 PM	121.4	0.193	60	22	0.95	0.97	14

c)

Radial Distance (ft)	Illuminance Foot Candles (FC) at 2ft height				
	0	45	90	135	180
0	4.80	4.80	4.80	4.80	4.80
4	3.16	5.39	5.46	5.43	5.13
8	3.09	2.37	2.72	2.87	4.06
12		1.44	1.22	1.54	1.65
16			0.61	0.73	0.65
20			0.45	0.30	
24			0.32	0.13	
28			0.13	0.04	
32			0.04		
36			0.00		
40			0.00		

Radial Distance (ft)	Illuminance Foot Candles (FC) at 4ft height				
	0	45	90	135	180
0	10.32	10.32	10.32	10.32	10.32
4	5.78	9.63	7.82	7.69	9.36
8	2.36	3.36	2.63	3.12	4.32
12		0.39	0.89	1.14	1.31
16			0.54	0.37	0.26
20			0.18	0.18	
24			0.05	0.05	
28			0.02	0.02	
32			0.00		
36			0.00		
40			0.00		

Radial Distance (ft)	Illuminance Foot Candles (FC) at 6ft height				
	0	45	90	135	180
0	16.76	16.76	16.76	16.76	16.76
4	12.90	10.04	10.26	11.97	2.40
8	0.65	1.32	2.27	3.00	0.26
12		0.07	0.65	0.39	0.12
16			0.14	0.07	
20			0.01	0.03	
24			0.00	0.01	
28			0.00	0.00	
32			0.00		
36			0.00		
40			0.00		

Table III: Beta 40 LED (Medium Driver Setting) a) Floor Level Illuminance, b) Power Consumption, and c) Illuminance at 2, 4, & 6 Feet Heights on Measurement Grid

a)

Radial Distance (ft)	Illuminance Foot Candles (FC) Along Radial Lines at Given Angles													
	0	15	30	45	60	75	90	105	120	135	150	165	180	
0	5.84	5.84	5.84	5.84	5.84	5.84	5.84	5.84	5.84	5.84	5.84	5.84	5.84	5.84
2	4.87	4.77	4.70	4.46	4.79	4.97	4.98	4.98	4.94	4.94	4.87	4.80	4.64	
4	2.84	3.12	3.68	3.70	3.81	4.50	4.96	5.14	5.02	4.79	4.42	4.43	4.56	
6	2.65	2.78	3.34	4.29	5.05	4.43	4.28	4.28	4.16	4.01	3.84	3.92	4.59	
8	3.01	2.87	2.60	3.18	4.06	3.76	3.12	2.91	2.91	2.97	3.17	3.35	4.39	
10	2.61	2.46	2.36	1.97	2.60	2.52	2.19	2.06	2.25	2.51	2.58	2.45	3.63	
12				1.70	1.56	1.74	1.69	1.57	1.75	1.96	1.80	1.93	2.83	
14				1.44	1.08	1.26	1.24	1.22	1.52	1.42	1.33	1.48	1.47	
16					0.90	0.86	0.90	0.93	1.08	1.18	1.14	0.90	1.08	
18					0.79	0.64	0.63	0.69	1.16	0.89	0.92	0.55		
20					0.69	0.51	0.47	0.55	0.91	0.72	0.52	0.37		
22					0.55	0.39	0.39	0.47	0.67	0.52	0.32			
24						0.31	0.34	0.39	0.48	0.35				
26						0.26	0.29	0.34	0.33	0.25				
28						0.23	0.26	0.28	0.26	0.17				
30						0.20	0.23	0.24	0.21					
32						0.17	0.18	0.18	0.17					
34						0.14	0.14	0.14	0.15					
36						0.11	0.12	0.12	0.12					
38						0.07	0.10	0.09	0.09					
40						0.00	0.10	0.07	0.07					
42									0.06					

b)

Electrical Parameters

	Voltage	Current	Frequency	Power	PF	DPF	%THD r
S: 11:13 AM	120.6	0.29	60	34	0.98	0.99	11.4
11:27 AM	120.7	0.285	60	34	0.97	0.98	11.5
12:21 PM	120.7	0.283	60	33	0.97	0.98	11.5
E: 1:24 PM	120.9	0.282	60	33	0.97	0.98	11.6

c)

Radial Distance (ft)	Illuminance Foot Candles (FC) at 2ft height				
	0	45	90	135	180
0	7.21	7.21	7.21	7.21	7.21
4	4.40	8.52	7.43	7.51	7.33
8	5.06	3.67	3.46	4.44	5.92
12		1.98	1.65	2.31	2.28
16			0.89	1.14	1.09
20			0.65	0.47	
24			0.31	0.25	
28			0.12	0.13	
32			0.08		
36			0.01		
40			0.03		

Radial Distance (ft)	Illuminance Foot Candles (FC) at 4ft height				
	0	45	90	135	180
0	12.21	12.21	12.21	12.21	12.21
4	8.71	13.35	10.78	11.19	12.67
8	3.27	4.86	3.53	5.26	6.35
12		0.64	1.67	2.05	1.82
16			0.79	0.69	0.45
20			0.39	0.26	
24			0.12	0.08	
28			0.06	0.07	
32			0.03		
36			0.03		
40			0.02		

Radial Distance (ft)	Illuminance Foot Candles (FC) at 6ft height				
	0	45	90	135	180
0	19.45	19.45	19.45	19.45	19.45
4	15.65	13.42	14.39	16.34	24.45
8	1.26	1.48	3.15	4.12	3.89
12		0.11	0.89	0.67	0.39
16			0.26	0.25	0.19
20			0.03	0.09	
24			0.01	0.03	
28			0.02	0.02	
32			0.01		
36			0.02		
40			0.01		

Table IV: Beta 40 LED (High Driver Setting) a) Floor Level Illuminance, b) Power Consumption, and c) Illuminance at 2, 4, & 6 Feet Heights on Measurement Grid

a)

Radial Distance (ft)	Illuminance Foot Candles (FC) Along Radial Lines at Given Angles													
	0	15	30	45	60	75	90	105	120	135	150	165	180	
0	7.14	7.14	7.14	7.14	7.14	7.14	7.14	7.14	7.14	7.14	7.14	7.14	7.14	7.14
2	5.60	5.85	5.77	5.91	6.18	6.46	6.47	6.40	6.33	6.37	6.35	6.26	6.03	
4	5.59	3.94	4.69	4.88	4.94	5.84	6.46	6.69	6.54	3.25	5.73	5.75	5.98	
6	3.42	3.61	4.38	5.78	6.59	5.80	5.57	5.52	5.38	5.21	4.97	5.10	6.00	
8	3.87	3.71	3.40	4.11	5.34	4.87	4.08	3.76	3.77	3.86	4.12	4.36	5.78	
10	3.26	3.21	3.08	2.56	3.34	3.27	2.86	2.67	2.94	3.28	3.33	3.17	4.76	
12				2.20	2.00	2.29	2.17	2.04	2.24	2.55	2.30	2.50	3.64	
14				1.86	1.40	1.60	1.59	1.58	1.97	1.84	1.72	1.91	1.94	
16					1.18	1.08	1.15	1.20	1.41	1.53	1.41	1.15	1.43	
18					1.03	0.81	0.81	0.89	1.46	1.15	1.16	0.71		
20					0.91	0.64	0.57	0.73	1.18	0.93	0.65	0.48		
22					0.72	0.49	0.50	0.62	0.87	0.61	0.39			
24						0.39	0.43	0.50	0.61	0.45				
26						0.33	0.38	0.43	0.47	0.32				
28						0.29	0.33	0.36	0.33	0.22				
30						0.26	0.27	0.30	0.26					
32						0.21	0.24	0.23	0.22					
34						0.17	0.17	0.17	0.18					
36						0.13	0.13	0.13	0.14					
38						0.09	0.11	0.11	0.11					
40						0.08	0.10	0.09	0.09					
42									0.07					

b)

Electrical Parameters

	Voltage	Current	Frequency	Power	PF	DPF	%THD r
S: 5:15 PM	120.7	0.398	60	47	0.98	0.99	9.4
5:51 PM	121.4	0.388	60	46	0.98	0.99	10
E: 6:04 PM	121.1	0.389	60	46	0.98	0.99	9.8

c)

Radial Distance (ft)	Illuminance Foot Candles (FC) at 2ft height				
	0	45	90	135	180
0	11.10	11.10	11.10	11.10	11.10
4	5.94	11.08	10.03	9.90	9.49
8	6.05	4.28	4.44	5.61	7.51
12		2.50	1.90	2.92	3.08
16			1.08	1.01	1.19
20			0.80	0.56	
24			0.44	0.26	
28			0.23	0.15	
32			0.09		
36			0.04		
40			0.03		

Radial Distance (ft)	Illuminance Foot Candles (FC) at 4ft height				
	0	45	90	135	180
0	19.42	19.42	19.42	19.42	19.42
4	11.43	15.68	14.02	13.54	16.59
8	4.33	6.04	4.18	5.56	7.78
12		0.79	2.11	2.29	2.50
16			1.15	0.54	0.36
20			0.29	0.34	
24			0.15	0.13	
28			0.07	0.05	
32			0.03		
36			0.02		
40			0.02		

Radial Distance (ft)	Illuminance Foot Candles (FC) at 6ft height				
	0	45	90	135	180
0	28.29	28.29	28.29	28.29	28.29
4	21.55	17.91	18.68	22.60	33.24
8	1.39	1.93	4.84	5.38	4.76
12		0.15	1.47	0.77	0.52
16			0.30	0.22	0.26
20			0.09	0.10	
24			0.08	0.05	
28			0.02	0.02	
32			0.01		
36			0.01		
40			0.01		

Table V: Beta 60 LED (Low Driver Setting) a) Floor Level Illuminance, b) Power Consumption, and c) Illuminance at 2, 4, & 6 Feet Heights on Measurement Grid

a)

Radial Distance (ft)	Illuminance Foot Candles (FC) Along Radial Lines at Given Angles												
	0	15	30	45	60	75	90	105	120	135	150	165	180
0	11.66	11.66	11.66	11.66	11.66	11.66	11.66	11.66	11.66	11.66	11.66	11.66	11.66
2	9.87	10.33	10.28	10.49	10.70	11.05	11.03	10.96	10.84	10.69	10.64	10.54	10.02
4	6.06	6.56	7.75	8.36	8.55	10.10	11.09	11.52	11.16	10.52	9.57	9.41	9.72
6	5.80	6.18	7.38	9.68	11.15	9.96	9.34	9.84	8.88	8.78	7.77	7.74	9.44
8	6.61	6.44	5.69	6.74	8.93	8.30	6.63	6.02	5.83	5.79	6.62	7.25	9.69
10	5.69	5.55	5.24	4.13	5.46	5.54	4.53	3.98	4.17	5.26	5.27	5.02	8.41
12				3.79	3.26	3.88	3.46	3.05	3.14	3.45	3.31	4.06	6.07
14				3.27	2.26	2.75	2.68	2.48	2.57	2.86	3.05	3.32	3.02
16					1.98	1.94	2.01	2.00	2.26	3.15	3.02	2.07	2.49
18					1.84	1.50	1.57	1.71	2.87	2.82	2.27	1.47	
20					1.57	1.15	1.27	1.46	2.82	1.84	1.63	1.14	
22					1.20	0.93	1.14	1.39	2.05	1.44	1.15		
24						0.82	1.01	1.21	1.33	1.17			
26						0.76	0.87	1.02	1.07	0.87			
28						0.67	0.71	0.79	0.85	0.65			
30						0.55	0.55	0.61	0.67				
32						0.44	0.42	0.45	0.52				
34						0.35	0.31	0.34	0.44				
36						0.27	0.25	0.25	0.34				
38						0.17	0.20	0.19	0.27				
40						0.16	0.17	0.14	0.23				
42									0.18				

b)

Electrical Parameters

	Voltage	Current	Frequency	Power	PF	DPF	%THD r
S: 10:16 AM	120.7	0.808	60	98	1	1	3.4
10:28 AM	120.7	0.802	60	97	1	1	3.5
E: 10:42 AM	121.1	0.799	60	97	1	1	3.9

c)

Radial Distance (ft)	Illuminance Foot Candles (FC) at 2ft height				
	0	45	90	135	180
0	14.34	14.34	14.34	14.34	14.34
4	9.07	14.63	16.97	15.81	15.22
8	11.05	6.78	7.29	8.55	12.15
12		4.82	4.15	5.53	4.77
16			1.63	3.35	2.52
20			1.88	1.76	
24			1.07	0.99	
28			0.54	0.62	
32			0.29		
36			0.15		
40			0.11		

Radial Distance (ft)	Illuminance Foot Candles (FC) at 4ft height				
	0	45	90	135	180
0	32.47	32.47	32.47	32.47	32.47
4	17.73	26.03	23.24	18.34	25.62
8	6.99	10.20	8.10	7.53	13.44
12		1.15	3.85	5.33	4.38
16			2.48	2.39	1.24
20			0.97	0.87	
24			0.40	0.44	
28			0.15	0.21	
32			0.08		
36			0.08		
40			0.01		

Radial Distance (ft)	Illuminance Foot Candles (FC) at 6ft height				
	0	45	90	135	180
0	*66.2	*66.2	*66.2	*66.2	*66.2
4	32.45	28.59	26.78	30.82	*51.8
8	1.86	4.52	7.75	13.04	10.30
12		0.08	3.71	3.84	1.75
16			0.65	0.39	0.44
20			0.15	0.14	
24			0.04	0.08	
28			0.04	0.05	
32			0.02		
36			0.00		
40			0.00		

Table VI: Beta 60 LED (Medium Driver Setting) a) Floor Level Illuminance, b) Power Consumption, and c) Illuminance at 2, 4, & 6 Feet Heights on Measurement Grid

a)

Radial Distance (ft)	Illuminance Foot Candles (FC) Along Radial Lines at Given Angles													
	0	15	30	45	60	75	90	105	120	135	150	165	180	
0	13.15	13.15	13.15	13.15	13.15	13.15	13.15	13.15	13.15	13.15	13.15	13.15	13.15	13.15
2	11.42	11.69	11.60	11.66	11.93	12.30	12.23	11.97	11.91	11.71	11.61	11.50	10.98	
4	6.88	7.36	8.77	9.34	9.47	11.21	12.31	12.64	12.28	11.49	10.45	10.32	10.60	
6	6.45	6.90	8.22	10.76	12.36	10.96	10.37	10.27	9.74	9.06	8.48	8.49	10.36	
8	7.35	7.12	6.36	7.57	9.94	9.18	7.38	6.57	6.39	6.42	7.30	7.98	10.57	
10	6.39	6.20	5.81	4.60	6.10	6.07	5.00	4.37	4.59	5.77	5.77	5.47	9.19	
12				4.19	3.66	4.32	3.82	3.33	3.38	3.81	3.61	4.37	6.59	
14				3.63	2.49	3.04	2.94	2.69	2.82	3.17	3.36	2.59	3.30	
16					2.19	2.15	2.22	2.20	2.49	3.47	3.33	2.23	2.69	
18					2.02	1.65	1.71	1.86	3.14	3.05	2.48	1.62		
20					1.72	1.27	1.41	1.59	3.12	2.00	1.76	1.38		
22					1.35	1.03	1.24	1.49	2.20	1.57	1.23			
24						0.91	1.10	1.28	1.43	1.26				
26						0.83	0.94	1.11	1.16	0.95				
28						0.74	0.80	0.86	0.87	0.72				
30						0.60	0.63	0.65	0.72					
32						0.49	0.48	0.48	0.57					
34						0.35	0.37	0.36	0.47					
36						0.30	0.28	0.26	0.36					
38						0.22	0.22	0.19	0.28					
40						0.14	0.18	0.14	0.23					
42									0.19					

b)

Electrical Parameters

	Voltage	Current	Frequency	Power	PF	DPF	%THD r
S: 9:35 AM	121	0.929	60	112	1	1	2.8
9:50 AM	120.5	0.917	60	110	1	1	2.9
E: 10:10 AM	120.5	0.909	60	109	1	1	3.2

c)

Radial Distance (ft)	Illuminance Foot Candles (FC) at 2ft height				
	0	45	90	135	180
0	14.36	14.36	14.36	14.36	14.36
4	10.43	16.57	17.87	16.91	16.49
8	12.36	8.23	7.82	9.48	14.15
12		5.71	3.56	5.36	5.38
16			1.99	3.71	2.89
20			1.65	1.82	
24			0.89	0.90	
28			0.48	0.45	
32			0.17		
36			0.10		
40			0.04		

Radial Distance (ft)	Illuminance Foot Candles (FC) at 4ft height				
	0	45	90	135	180
0	23.51	23.51	23.51	23.51	23.51
4	*20.3	32.42	25.67	25.38	28.13
8	8.97	12.76	8.51	9.77	14.90
12		1.82	4.07	6.61	5.25
16			2.27	2.53	1.49
20			1.01	1.17	
24			0.34	0.52	
28			0.15	0.18	
32			0.07		
36			0.04		
40			0.02		

Radial Distance (ft)	Illuminance Foot Candles (FC) at 6ft height				
	0	45	90	135	180
0	*44.4	*44.4	*44.4	*44.4	*44.4
4	*40.1	34.60	28.91	35.45	*59.4
8	3.12	5.29	9.41	15.13	10.63
12		0.38	3.91	3.42	1.38
16			0.73	0.92	0.43
20			0.17	0.29	
24			0.09	0.13	
28			0.04	0.08	
32			0.03		
36			0.02		
40			0.00		

Table VII: Beta 60 LED (High Driver Setting) a) Floor Level Illuminance, b) Power Consumption, and c) Illuminance at 2, 4, & 6 Feet Heights on Measurement Grid

a)

Radial Distance (ft)	Illuminance Foot Candles (FC) Along Radial Lines at Given Angles													
	0	15	30	45	60	75	90	105	120	135	150	165	180	
0	13.42	13.42	13.42	13.42	13.42	13.42	13.42	13.42	13.42	13.42	13.42	13.42	13.42	13.42
2	11.53	11.80	11.84	11.91	12.19	12.58	12.59	12.52	12.35	12.18	11.99	12.01	11.58	
4	6.97	7.58	8.92	9.61	9.84	11.64	12.78	13.23	12.76	12.00	10.89	10.61	11.14	
6	6.64	7.14	8.52	11.16	12.76	11.25	10.62	10.62	10.13	9.38	8.83	8.70	10.92	
8	7.63	7.36	6.51	7.66	10.31	9.44	7.59	6.81	6.57	6.66	7.61	8.23	11.10	
10	6.62	6.34	6.03	4.75	6.28	6.24	5.16	4.55	4.79	5.95	6.01	5.68	9.68	
12				7.35	3.71	4.39	3.96	3.46	3.55	3.88	3.70	4.60	6.80	
14				3.75	2.59	3.11	3.06	2.81	2.95	3.29	3.51	3.80	3.42	
16					2.26	2.20	2.30	2.30	2.63	3.64	3.44	2.36	2.85	
18					2.13	1.71	1.81	1.93	3.28	3.14	2.55	1.70		
20					1.79	1.31	1.45	1.70	3.24	2.07	1.82	1.30		
22					1.42	1.06	1.30	1.60	2.28	1.62	1.28			
24						0.95	1.16	1.35	1.43	1.29				
26						0.89	0.99	1.14	1.21	0.97				
28						0.77	0.81	0.88	0.96	0.74				
30						0.63	0.64	0.66	0.76					
32						0.50	0.49	0.50	0.59					
34						0.39	0.38	0.37	0.49					
36						0.31	0.29	0.26	0.38					
38						0.22	0.23	0.20	0.30					
40						0.19	0.19	0.14	0.26					
42									0.20					

b)

Electrical Parameters

	Voltage	Current	Frequency	Power	PF	DPF	%THD r
S: 10:46 AM	120.6	1.034	60	125	1	1	2.8
10:58 AM	121.1	1.03	60	125	1	1	2.9
E: 11:14 AM	121	1.026	60	124	1	1	3.1

c)

Radial Distance (ft)	Illuminance Foot Candles (FC) at 2ft height				
	0	45	90	135	180
0	14.15	14.15	14.15	14.15	14.15
4	*10.7	17.67	20.25	19.49	18.34
8	*12.08	7.95	8.26	10.40	14.76
12		5.70	4.86	5.35	5.87
16			2.59	3.74	3.08
20			2.07	2.07	
24			1.19	1.08	
28			0.45	0.56	
32			0.32		
36			0.06		
40			0.04		

Radial Distance (ft)	Illuminance Foot Candles (FC) at 4ft height				
	0	45	90	135	180
0	31.65	31.65	31.65	31.65	31.65
4	*21.4	31.67	26.75	26.84	31.37
8	*8.8	12.36	9.70	10.62	16.03
12		2.10	4.71	6.43	6.73
16			3.20	2.79	1.69
20			1.24	1.23	
24			0.42	0.52	
28			0.23	0.28	
32			0.08		
36			0.05		
40			0.02		

Radial Distance (ft)	Illuminance Foot Candles (FC) at 6ft height				
	0	45	90	135	180
0	*48.9	*48.9	*48.9	*48.9	*48.9
4	*38.5	35.23	30.40	35.40	*61.3
8	3.26	6.23	9.96	16.50	14.09
12		0.33	4.95	3.36	2.31
16			1.14	0.94	0.56
20			0.19	0.31	
24			0.11	0.13	
28			0.05	0.11	
32			0.03		
36			0.02		
40			0.02		

Table VIII: Dolphin 90 LED a) Floor Level Illuminance, b) Power Consumption, and c) Illuminance at 2, 4, & 6 Feet Heights on Measurement Grid

a)

Radial Distance (ft)	Illuminance Foot Candles (FC) Along Radial Lines at Given Angles													
	0	15	30	45	60	75	90	105	120	135	150	165	180	
0	6.95	6.95	6.95	6.95	6.95	6.95	6.95	6.95	6.95	6.95	6.95	6.95	6.95	6.95
2	6.65	6.83	6.91	6.68	6.62	6.66	6.71	6.84	7.10	7.38	7.75	7.95	8.06	
4	5.70	5.81	5.86	5.84	5.70	5.79	5.88	6.11	6.95	7.75	8.33	8.78	9.15	
6	4.70	4.77	4.91	4.95	4.83	4.87	4.91	5.21	6.31	7.10	7.24	7.14	7.04	
8	3.28	3.33	3.54	3.75	3.89	4.10	4.23	4.58	5.39	5.42	4.80	4.54	4.27	
10	2.29	2.25	2.38	2.65	3.08	4.04	4.45	4.77	4.54	3.53	3.05	2.89	2.84	
12				1.75	2.48	3.87	4.00	4.28	3.89	2.24	2.03	1.99	1.85	
14				1.19	2.04	3.02	2.93	3.15	3.00	1.59	1.42	1.38	1.23	
16					1.66	2.17	2.19	2.32	2.09	1.18	0.96	0.90	0.86	
18					1.74	1.53	1.57	1.70	1.35	0.96	0.66	0.63		
20					0.91	1.05	1.17	1.26	0.93	0.73	0.48	0.49		
22					0.66	0.79	0.90	0.96	0.69	0.56	0.37			
24						0.57	0.68	0.74	0.45	0.44				
26						0.43	0.50	0.56	0.36	0.33				
28						0.31	0.37	0.41	0.29	0.26				
30						0.22	0.28	0.32	0.24					
32						0.16	0.24	0.26	0.19					
34						0.12	0.18	0.21	0.15					
36						0.09	0.15	0.17	0.12					
38						0.05	0.13	0.15	0.09					
40						0.05	0.12	0.13	0.07					
42									0.05					

b)

Electrical Parameters

	Voltage	Current	Frequency	Power	PF	DPF	%THD r
S: 11:45 AM	120.9	0.774	60	90	0.96	1	24.2
11:57 AM	120.8	0.758	60	89	0.97	1	22.6
E: 12:10 PM	120.6	0.749	60	88	0.97	1	20.6

c)

Radial Distance (ft)	Illuminance Foot Candles (FC) at 2ft height				
	0	45	90	135	180
0	10.52	10.52	10.52	10.52	10.52
4	8.72	8.99	8.93	11.92	13.68
8	3.99	4.18	8.26	5.90	5.17
12		1.78	3.81	2.48	2.10
16			1.64	1.27	0.82
20			0.77	0.68	
24			0.39	0.35	
28			0.20	0.29	
32			0.15		
36			0.08		
40			0.06		

Radial Distance (ft)	Illuminance Foot Candles (FC) at 4ft height				
	0	45	90	135	180
0	19.60	19.60	19.60	19.60	19.60
4	12.40	13.82	13.80	18.29	18.94
8	3.86	3.94	8.99	5.27	4.97
12		1.62	3.15	2.23	1.56
16			1.04	0.85	0.61
20			0.41	0.45	
24			0.26	0.26	
28			0.13	0.13	
32			0.08		
36			0.06		
40			0.04		

Radial Distance (ft)	Illuminance Foot Candles (FC) at 6ft height				
	0	45	90	135	180
0	*43.1	*43.1	*43.1	*43.1	*43.1
4	14.92	16.67	34.73	22.08	21.59
8	3.08	3.68	7.64	4.86	3.16
12		1.04	1.34	1.06	0.73
16			0.40	0.49	0.18
20			0.16	0.13	
24			0.07	0.04	
28			0.05	0.04	
32			0.03		
36			0.02		
40			0.01		

Table IX: Dolphin 120 LED a) Floor Level Illuminance, b) Power Consumption, and c) Illuminance at 2, 4, & 6 Feet Heights on Measurement Grid

a)

Radial Distance (ft)	Illuminance Foot Candles (FC) Along Radial Lines at Given Angles												
	0	15	30	45	60	75	90	105	120	135	150	165	180
0	12.76	12.76	12.76	12.76	12.76	12.76	12.76	12.76	12.76	12.76	12.76	12.76	12.76
2	11.74	11.90	11.84	11.67	11.68	11.96	12.15	12.53	13.39	13.90	14.53	14.83	14.95
4	10.34	10.38	10.60	10.52	10.40	10.64	11.03	11.71	13.26	13.86	14.04	14.39	14.58
6	7.92	8.02	8.29	8.66	8.81	9.07	9.41	10.26	11.18	11.18	11.08	11.08	11.01
8	5.86	5.88	6.05	6.32	6.94	7.84	8.52	9.26	8.77	8.22	7.84	7.89	7.51
10	4.33	4.18	4.28	4.57	5.43	7.32	8.33	8.74	7.14	5.93	5.36	5.20	5.04
12				3.23	4.35	6.26	6.97	7.10	5.84	4.30	3.68	3.35	3.14
14				2.28	3.51	4.73	5.17	5.19	4.43	3.13	2.41	2.23	2.18
16					2.72	3.42	3.72	3.67	3.19	2.25	1.63	1.49	1.35
18					2.01	2.37	2.56	2.53	2.20	1.64	1.13	1.05	
20					1.45	1.64	1.86	1.82	1.65	1.15	0.82	0.78	
22					1.09	1.20	1.36	1.32	1.16	0.86	0.64		
24						0.90	0.96	0.93	0.81	0.66			
26						0.67	0.68	0.67	0.65	0.48			
28						0.50	0.50	0.49	0.48	0.38			
30						0.38	0.39	0.38	0.39				
32						0.29	0.31	0.30	0.29				
34						0.22	0.24	0.24	0.25				
36						0.18	0.20	0.19	0.19				
38						0.13	0.16	0.16	0.15				
40						0.12	0.14	0.13	0.13				
42									0.08				

b)

Electrical Parameters

	Voltage	Current	Frequency	Power	PF	DPF	%THD r
S: 12:32 PM	120	1.153	60	137	0.99	0.99	9.4
12:50 PM	120.3	1.13	60	134	0.99	0.99	9.9
E: 1:03 PM	120	1.126	60	133	0.99	0.99	10.5

c)

Radial Distance (ft)	Illuminance Foot Candles (FC) at 2ft height				
	0	45	90	135	180
0	10.32	10.32	10.32	10.32	10.32
4	15.27	16.43	16.84	20.89	20.71
8	7.58	8.03	13.98	10.78	9.02
12		3.52	6.47	4.79	3.45
16			2.78	2.11	1.41
20			1.07	1.17	
24			0.54	0.56	
28			0.30	0.38	
32			0.18		
36			0.12		
40			0.09		

Radial Distance (ft)	Illuminance Foot Candles (FC) at 4ft height				
	0	45	90	135	180
0	16.25	16.25	16.25	16.25	16.25
4	21.18	22.67	26.35	29.87	28.13
8	6.97	8.18	15.73	11.39	7.84
12		2.97	4.75	3.39	2.40
16			1.32	1.41	0.87
20			0.65	0.78	
24			0.40	0.37	
28			0.18	0.23	
32			0.13		
36			0.09		
40			0.06		

Radial Distance (ft)	Illuminance Foot Candles (FC) at 6ft height				
	0	45	90	135	180
0	*50.3	*50.3	*50.3	*50.3	*50.3
4	27.52	32.92	*56.7	34.50	33.56
8	5.92	5.84	11.08	7.53	5.79
12		1.70	1.95	1.57	1.14
16			0.59	0.70	0.20
20			0.32	0.20	
24			0.13	0.09	
28			0.10	0.07	
32			0.07		
36			0.05		
40			0.04		

Table X: HPS 150 a) Floor Level Illuminance, b) Power Consumption, and c) Illuminance at 2, 4, & 6 Feet Heights on Measurement Grid

a)

Radial Distance (ft)	Illuminance Foot Candles (FC) Along Radial Lines at Given Angles												
	0	15	30	45	60	75	90	105	120	135	150	165	180
0	25.94	25.94	25.94	25.94	25.94	25.94	25.94	25.94	25.94	25.94	25.94	25.94	25.94
2	19.21	19.84	20.19	20.56	21.56	22.44	23.32	24.00	25.42	26.98	28.04	28.55	28.65
4	11.98	12.88	14.00	15.02	16.70	18.35	19.56	20.27	22.00	23.50	24.56	26.06	25.31
6	7.45	8.05	9.12	10.97	12.59	14.56	15.63	16.61	18.17	17.97	17.41	16.82	17.10
8	4.79	5.15	5.98	7.10	8.74	10.92	12.42	14.75	16.14	13.90	12.18	11.21	10.39
10	3.02	3.24	3.92	4.85	6.03	8.36	10.31	12.72	13.84	11.96	9.00	7.55	7.11
12				3.48	4.34	6.09	7.63	9.52	10.61	8.51	6.57	5.46	4.63
14				2.52	3.22	4.44	5.43	6.81	7.60	6.18	4.60	3.70	3.36
16					2.48	3.28	4.00	4.95	5.26	4.30	3.14	2.58	2.40
18					1.90	2.50	3.12	3.95	3.66	3.02	2.30	1.90	
20					1.45	1.92	2.61	3.42	2.63	2.03	1.72	1.40	
22					0.92	1.24	2.08	2.93	2.18	1.46	1.35		
24						0.73	1.48	2.29	1.76	1.12			
26						0.53	1.15	1.80	1.57	0.88			
28						0.42	1.00	1.45	1.26	0.68			
30						0.35	0.81	1.25	1.18				
32						0.29	0.69	1.05	1.05				
34						0.25	0.55	0.87	0.99				
36						0.20	0.46	0.69	0.84				
38						0.13	0.38	0.58	0.72				
40						0.13	0.33	0.46	0.62				
42									0.52				

b)

	Electrical Parameters						
	Voltage	Current	Frequency	Power	PF	DPF	%THD r
S: 3:54 PM	120.2	1.64	60	192	0.98	0.98	7.1
4:25 PM	120.4	1.647	60	194	0.98	0.98	7.3
E: 5:02 PM	120.2	1.644	60	194	0.98	0.99	7.1

c)

Radial Distance (ft)	Illuminance Foot Candles (FC) at 2ft height				
	0	45	90	135	180
0	*39.4	*39.4	*39.4	*39.4	*39.4
4	*14.1	*19.8	*27.1	*33.8	*33.7
8	*4.9	*6.8	*16.6	*18.2	*12.2
12		*3.2	*6.7	*7.8	*4.1
16			*4.6	*2.9	1.87
20			2.36	1.68	
24			1.56	0.78	
28			0.91	0.39	
32			0.55		
36			0.33		
40			0.22		

Radial Distance (ft)	Illuminance Foot Candles (FC) at 4ft height				
	0	45	90	135	180
0	*66.3	*66.3	*66.3	*66.3	*66.3
4	*19.4	*28.6	*39.5	*48.2	*43.9
8	*3.6	*7.5	*16.4	*18.1	*11.4
12		*2.6	*7.3	*5.2	*2.8
16			*3.3	*1.5	1.24
20			2.37	0.77	
24			0.95	0.32	
28			0.42	0.14	
32			0.22		
36			0.13		
40			0.08		

Radial Distance (ft)	Illuminance Foot Candles (FC) at 6ft height				
	0	45	90	135	180
0	*141	*141	*141	*141	*141
4	*18.5	*31.4	*61.6	*84.4	*62.8
8	*2.5	*5.2	*15.4	*15.4	*9.7
12		0.64	*5.8	*4	*3
16			*1.9	0.77	1.06
20			0.78	0.45	
24			0.26	0.26	
28			0.15	0.17	
32			0.12		
36			0.08		
40			0.06		

Table XI: HPS 250 a) Floor Level Illuminance, b) Power Consumption, and c) Illuminance at 2, 4, & 6 Feet Heights on Measurement Grid

a)

Radial Distance (ft)	Illuminance Foot Candles (FC) Along Radial Lines at Given Angles												
	0	15	30	45	60	75	90	105	120	135	150	165	180
0	35.31	35.31	35.31	35.31	35.31	35.31	35.31	35.31	35.31	35.31	35.31	35.31	35.31
2	32.75	32.05	32.73	33.92	34.60	34.80	34.99	34.79	34.62	34.21	33.35	33.36	29.14
4	25.26	26.34	28.14	29.07	29.15	29.32	29.67	30.79	33.40	33.87	33.86	28.94	13.45
6	19.90	19.86	20.29	21.45	22.91	22.73	22.45	22.95	25.30	27.97	31.84	27.50	16.95
8	15.38	13.64	13.76	15.93	17.76	17.63	17.34	17.63	20.15	22.62	25.86	24.50	12.50
10	9.34	8.80	9.45	11.23	12.37	13.50	13.00	13.49	16.39	18.20	17.82	16.93	8.11
12				8.26	9.14	9.67	10.01	10.65	13.29	14.17	14.47	11.06	5.87
14				6.04	6.98	7.47	7.86	8.68	11.84	11.13	10.35	7.05	3.96
16					5.10	5.73	6.44	7.17	10.18	8.29	6.97	4.87	
18					3.74	4.38	5.23	5.78	7.84	6.82	4.45	3.09	
20					2.69	3.30	4.32	4.58	6.35	4.85	2.65	1.93	
22					1.79	2.35	3.64	3.71	4.86	3.77	1.78		
24						1.59	2.90	3.10	3.66	3.13			
26						1.09	2.31	2.60	3.52	2.57			
28						0.79	1.92	2.11	3.23	2.24			
30						0.64	1.60	1.84	2.95				
32						0.53	1.34	1.52	2.46				
34						0.44	1.05	1.18	2.06				
36						0.36	0.80	0.90	1.54				
38						0.26	0.60	0.67	1.16				
40						0.24	0.48	0.49	0.83				
42									0.60				

b)

**Electrical Parameters
After Transformer**

	Voltage	Current	Frequency	Power	PF	DPF	%THD r
S: 5:20 PM	223.1	1.397	60	290	0.93	0.94	4.1
5:33 PM	223.1	1.383	60	281	0.91	0.91	4
E: 5:44 PM	223.9	1.382	60	282	0.91	0.91	3.9

c)

Radial Distance (ft)	Illuminance Foot Candles (FC) at 2ft height				
	0	45	90	135	180
0	*55.9	*55.9	*55.9	*55.9	*55.9
4	*33.6	*40.1	*37.8	*47.8	*43.6
8	*16.3	*17.3	*20.6	*26.1	*22.1
12		*6.6	*10.2	*15.1	8.68
16			*7.1	*6.6	2.23
20			*3.5	5.24	
24			*1.9	3.63	
28			*1.2	2.13	
32			*.4		
36			0.58		
40			0.22		

Radial Distance (ft)	Illuminance Foot Candles (FC) at 4ft height				
	0	45	90	135	180
0	*95.3	*95.3	*95.3	*95.3	*95.3
4	*52.5	*55.7	*59.6	*67.8	*61.8
8	*11	*18.3	*22	*34.5	*21.1
12		*5.5	*10.3	*17.6	4.77
16			*6.7	*7.5	1.22
20			*2.7	4.48	
24			*.7	1.31	
28			*.1	0.54	
32			0.38		
36			0.18		
40			0.17		

Radial Distance (ft)	Illuminance Foot Candles (FC) at 6ft height				
	0	45	90	135	180
0	*207.4	*207.4	*207.4	*207.4	*207.4
4	*64	*62.8	*76.6	*94.3	*91.4
8	*6.5	*10.7	*20.6	*22.3	*10.2
12		*.14	*7.3	*10.5	1.31
16			*1.2	*1.2	0.45
20			*.2	0.43	
24			0.39	0.26	
28			0.20	0.24	
32			0.13		
36			0.12		
40			0.11		

APPENDIX C: Contour and Surface Plots of Measured and Height Adjusted Illuminance on Measurement Grid

Figures 3-12: Contour Plots of Illuminance (fc) at Floor Level (0 feet) on Measurement Grid with Light at 10 Feet Height

Figures 13-22: Surface Plots of Illuminance (fc) at a) 0, b) 2, c) 4 and d) 6 Feet Heights on Measurement Grid

Figures 23-32: Contour Plots of Illuminance (fc) at Floor Level (0 feet) on Measurement Grid with Light at a) 20 Feet and b) 30 Feet Height

Figures 3-12: Contour Plots of Isoilluminance (fc) at Floor Level (0 feet) on Measurement Grid with Light at 10 Feet Height

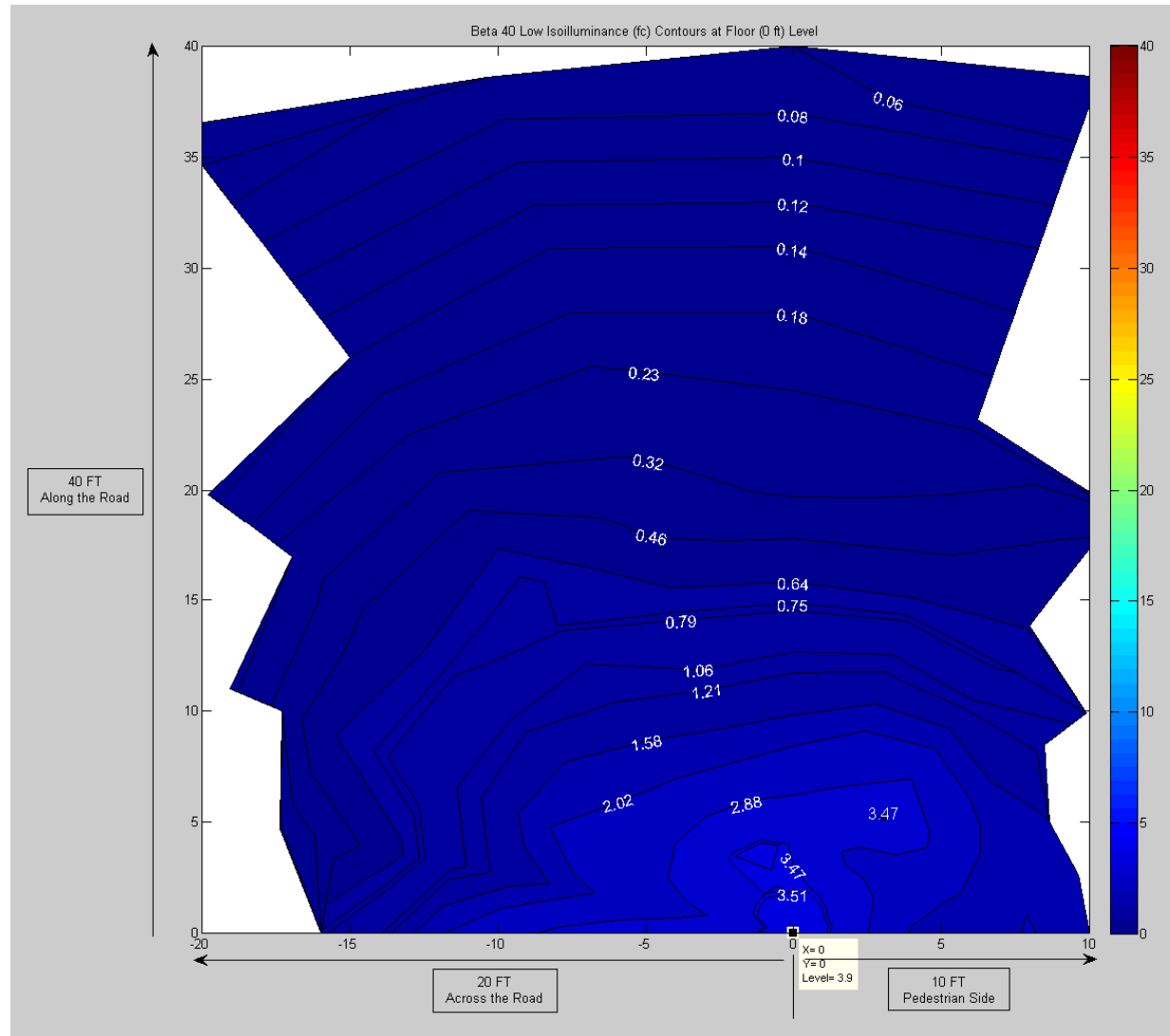

Figure 3: Contour Plot of Isoilluminance (fc) for Beta 40 LED Low Driver Setting at the Floor (0 Feet) Level on Measurement Grid

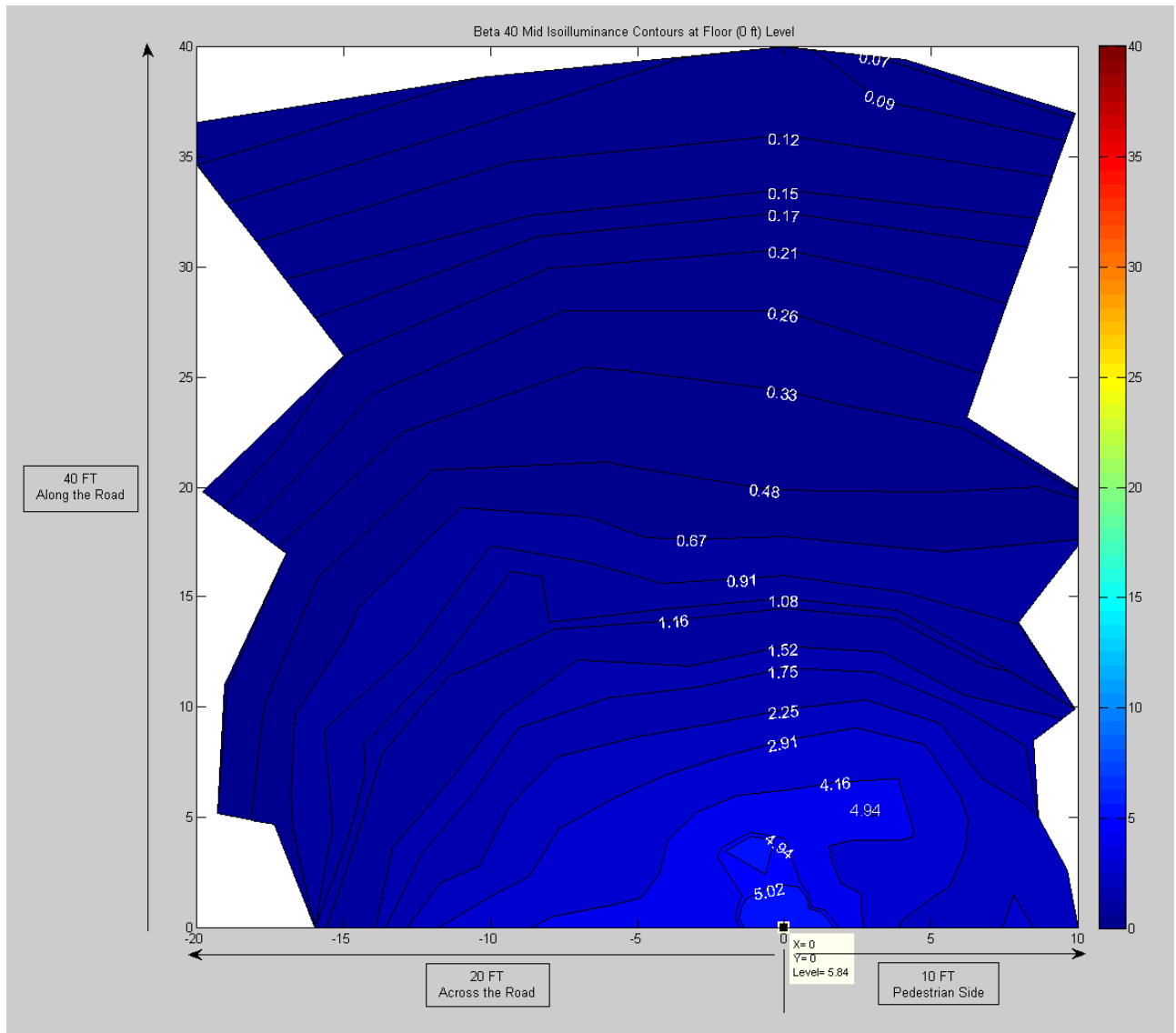

Figure 4: Contour Plot of Isoilluminance (fc) for Beta 40 LED Mid Driver Setting at the Floor (0 Feet) Level on Measurement Grid

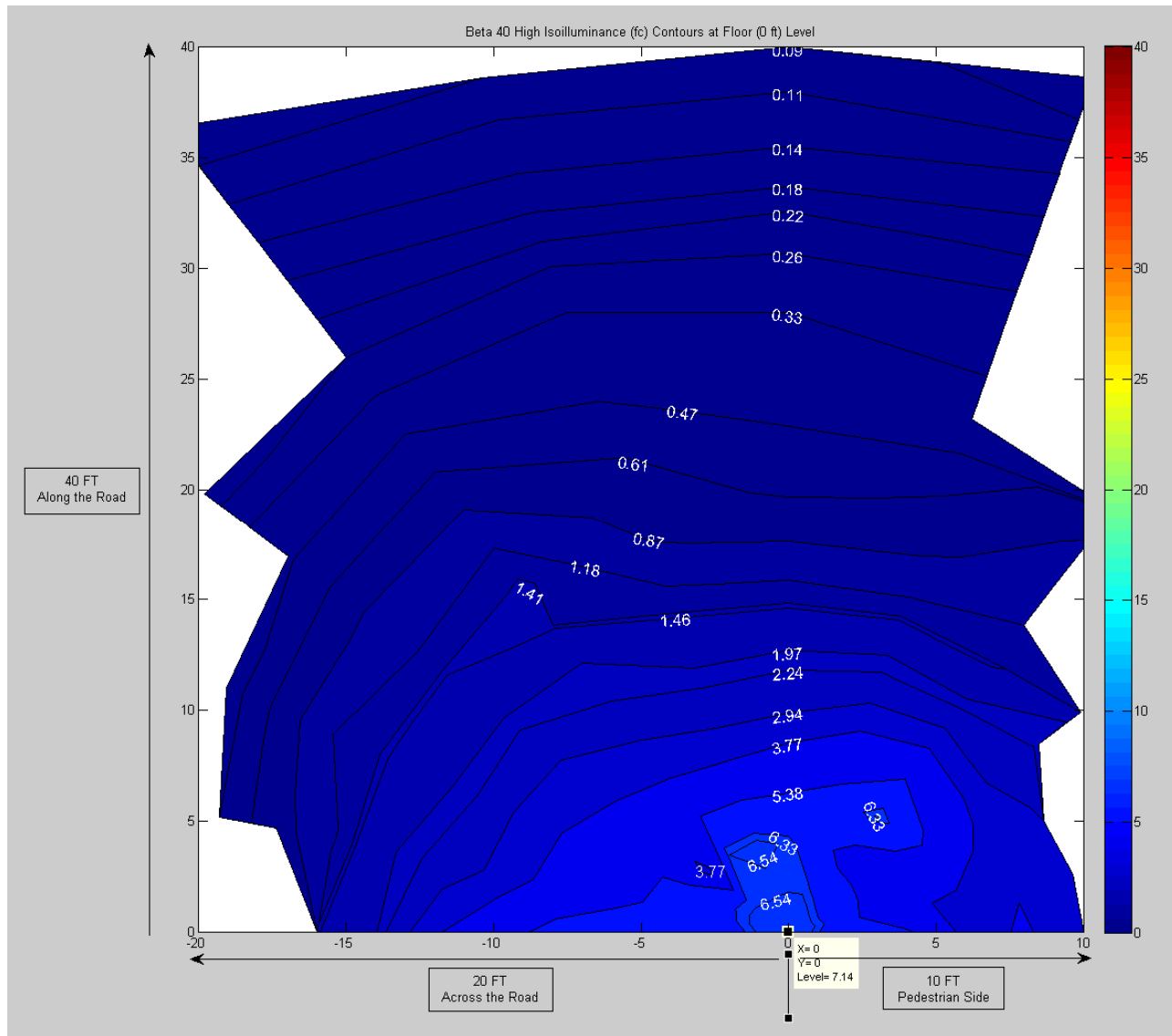

Figure 5: Contour Plot of Isoilluminance (fc) for Beta 40 LED High Driver Setting at the Floor (0 Feet) Level on Measurement Grid

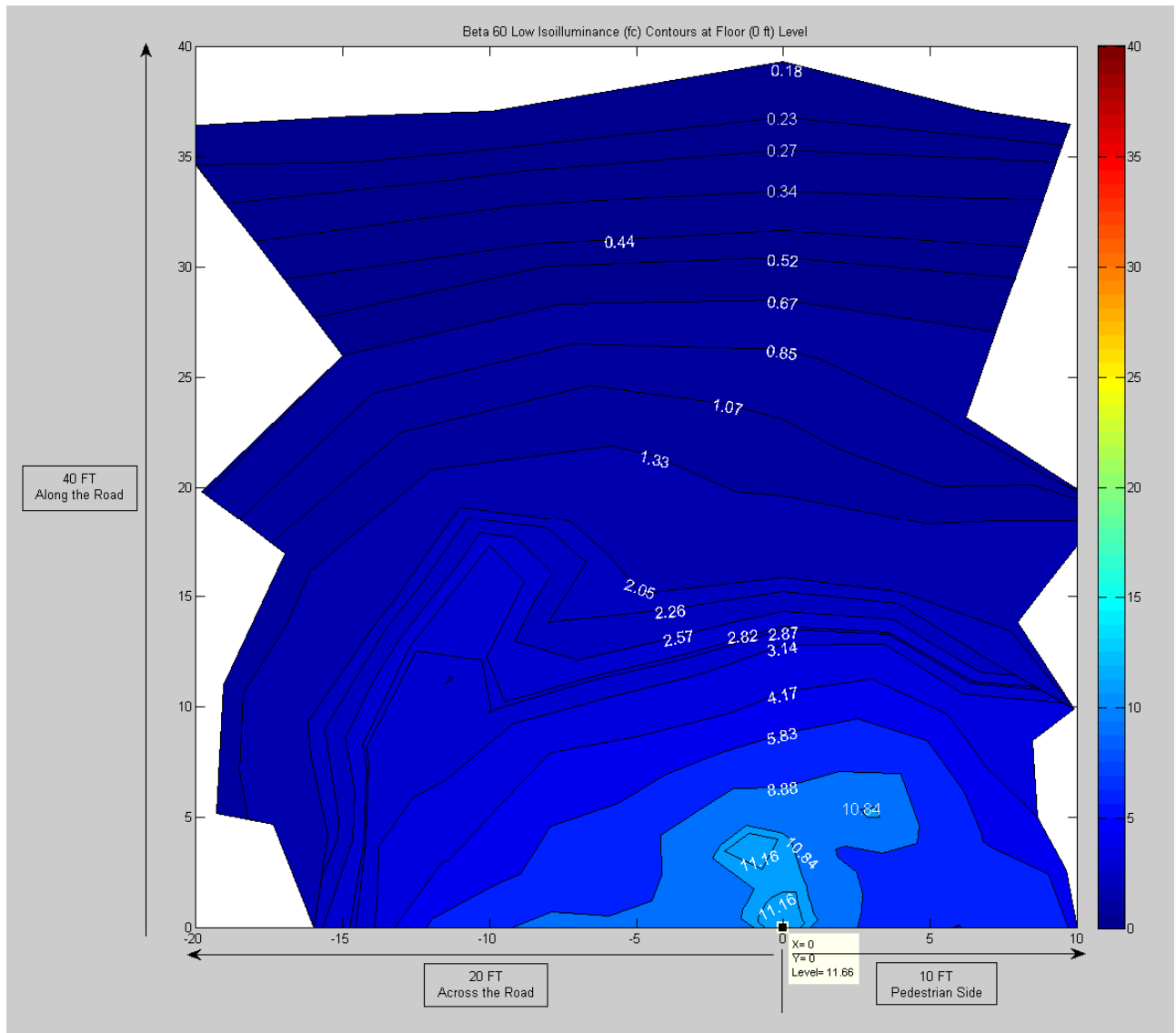

Figure 6: Contour Plot of Isoilluminance (fc) for Beta 60 LED Low Driver Setting at the Floor (0 Feet) Level on Measurement Grid

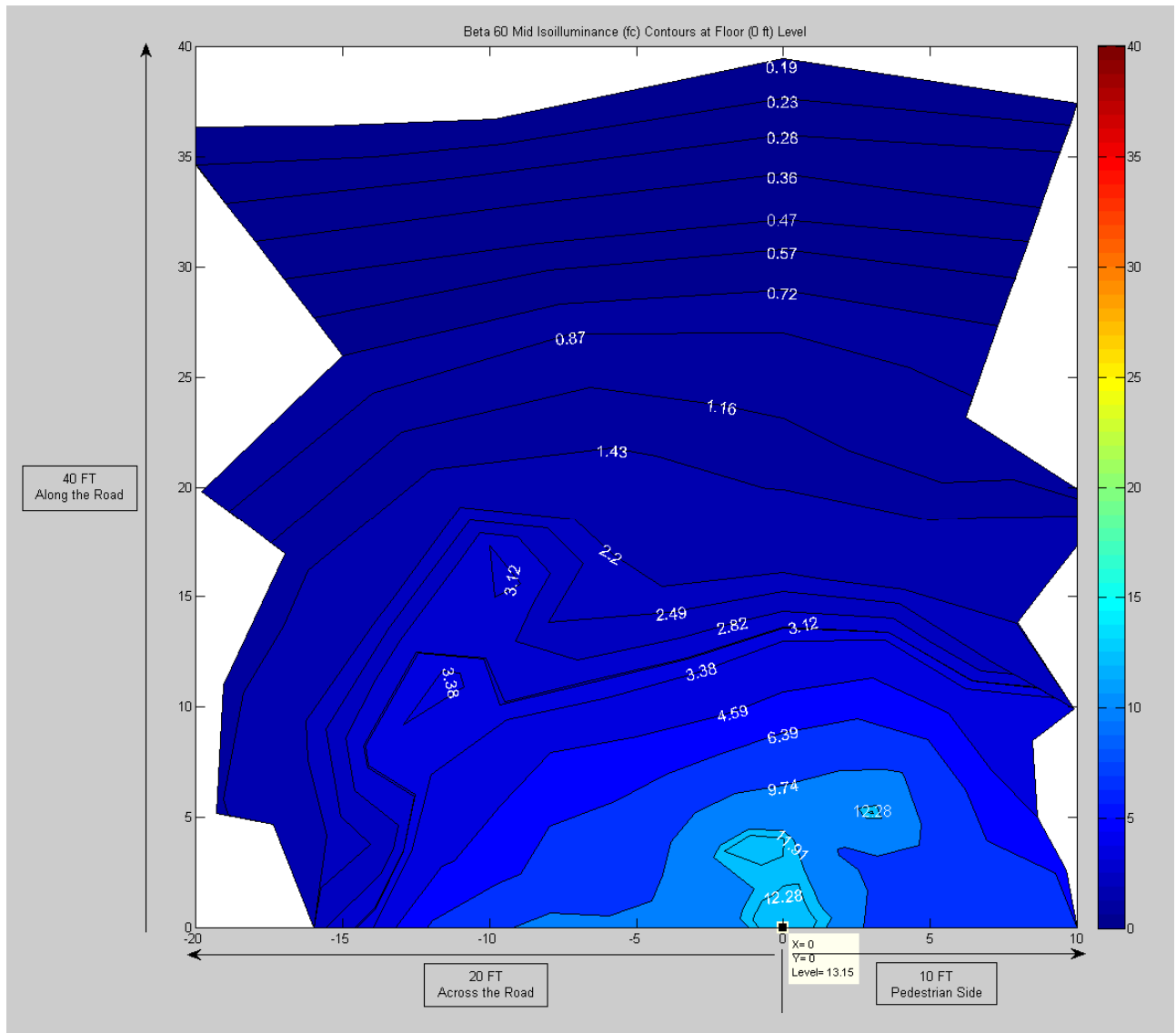

Figure 7: Contour Plot of Isoilluminance (fc) for Beta 60 LED Mid Driver Setting at the Floor (0 Feet) Level on Measurement Grid

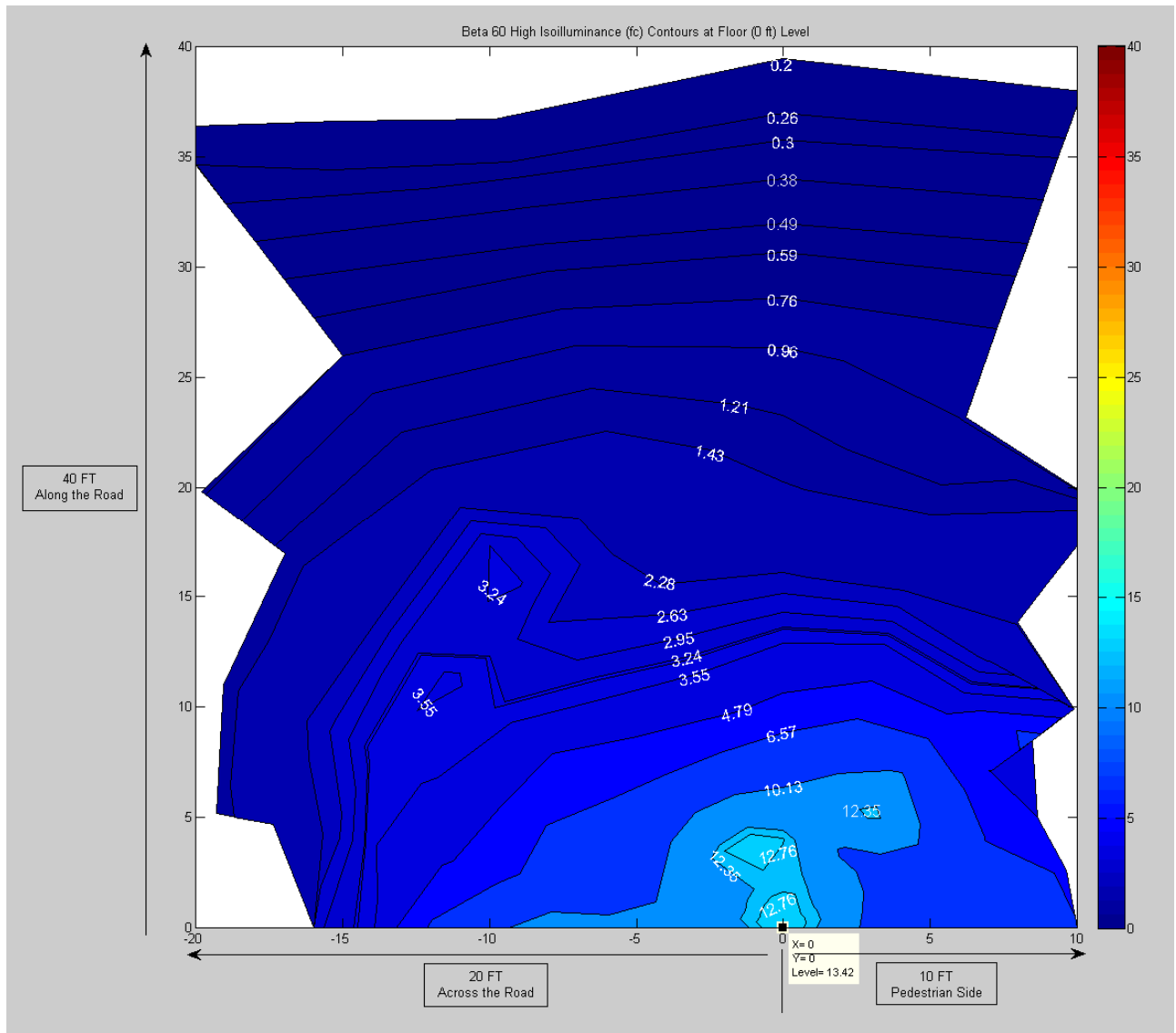

Figure 8: Contour Plot of Isoilluminance (fc) for Beta 60 LED High Driver Setting at the Floor (0 Feet) Level on Measurement Grid

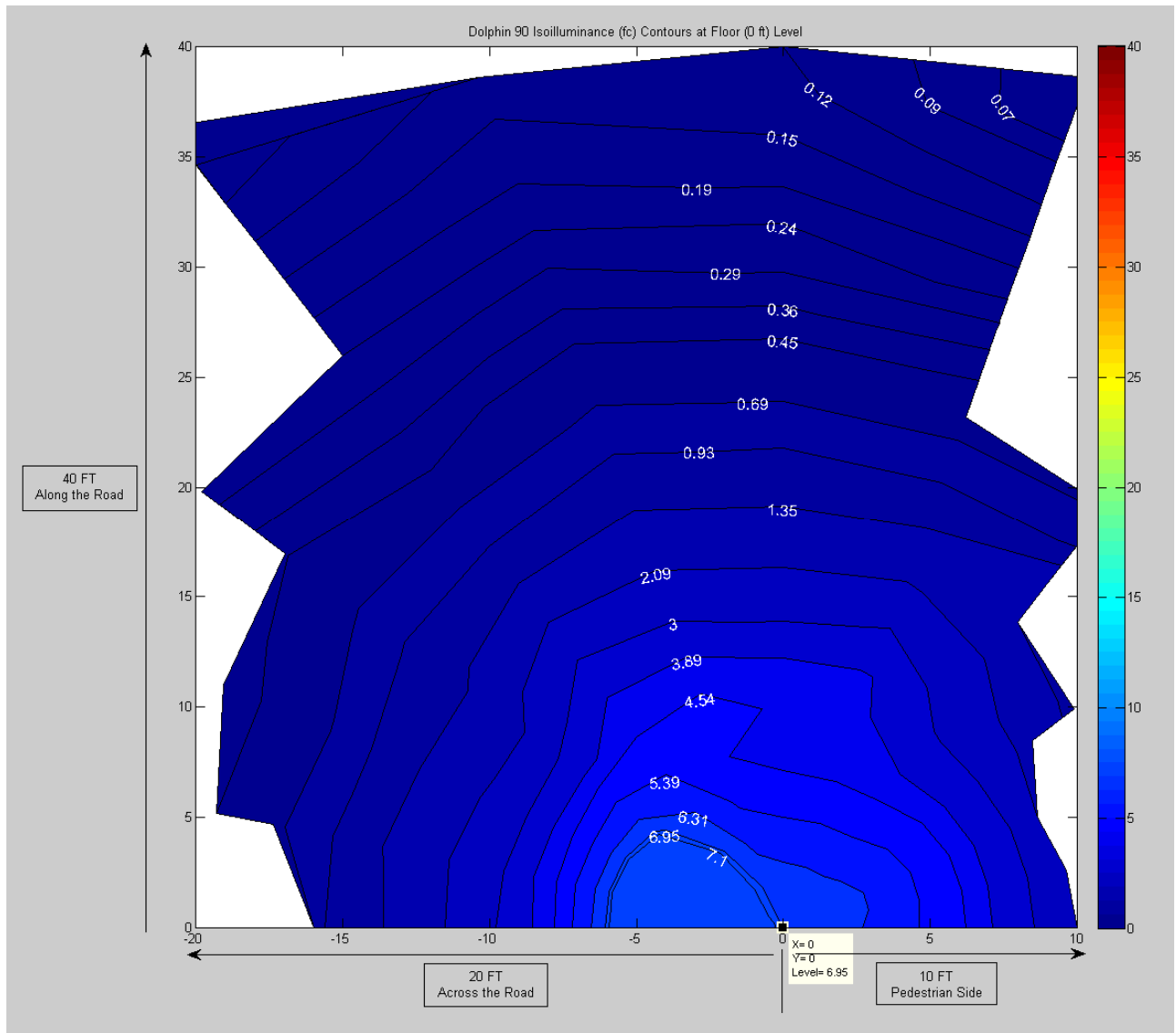

Figure 9: Contour Plot of Isoilluminance (fc) for Dolphin 90 LED at the Floor (0 Feet) Level on Measurement Grid

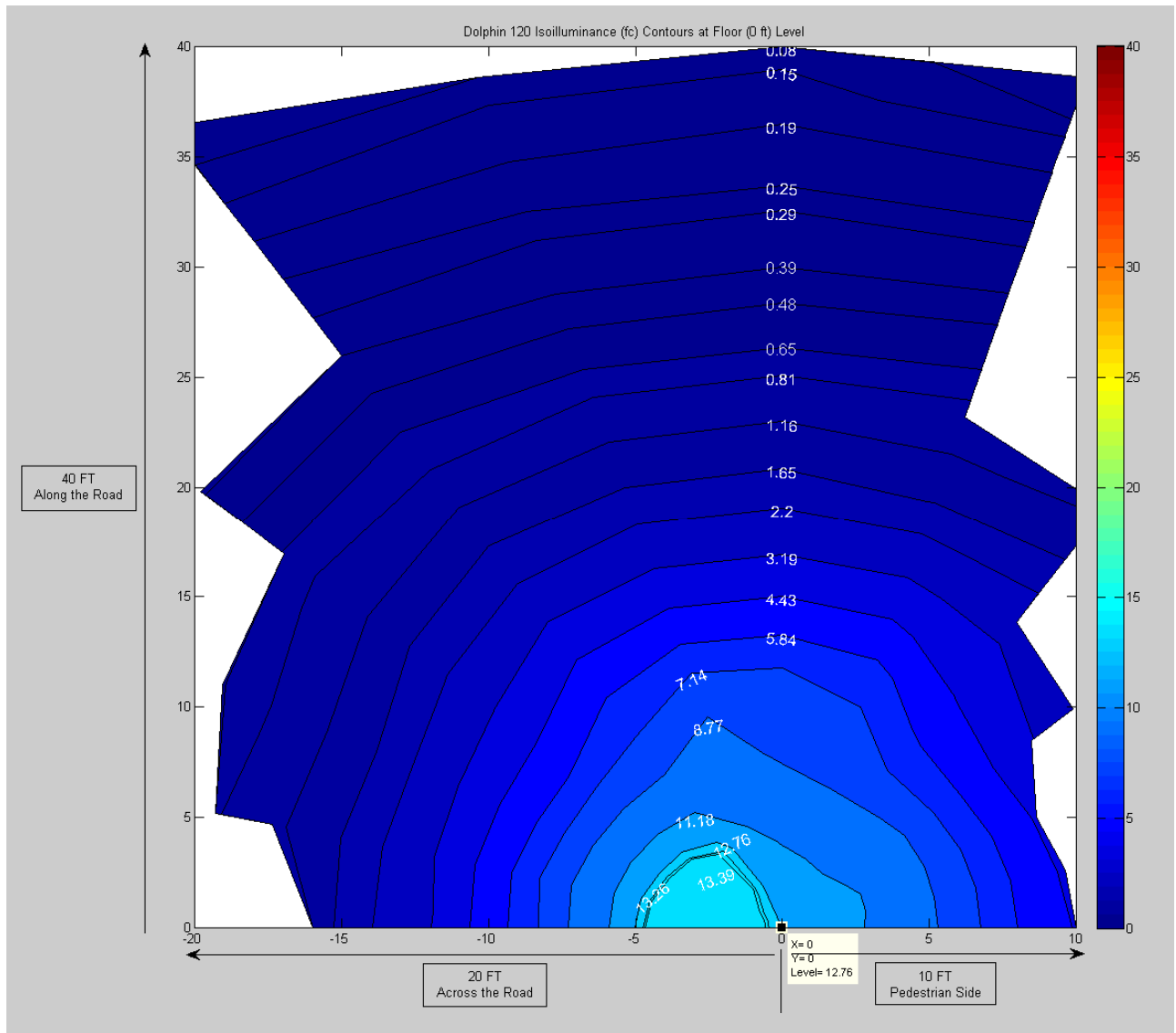

Figure 10: Contour Plot of Isoilluminance (fc) for Dolphin 120 LED at the Floor (0 Feet) Level on Measurement Grid

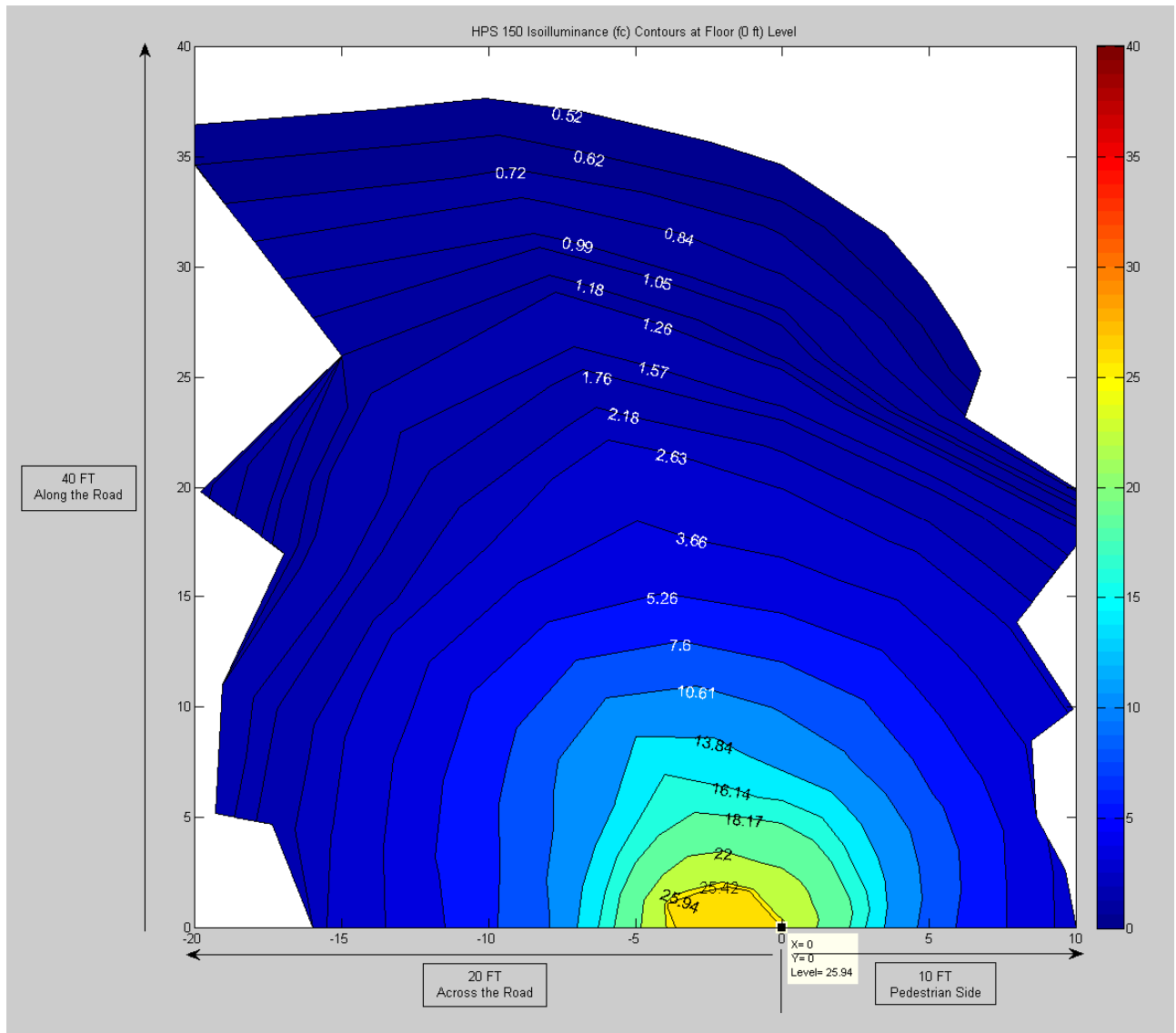

Figure 11: Contour Plot of Isoilluminance (fc) for HPS 150 at the Floor (0 Feet) Level on Measurement Grid

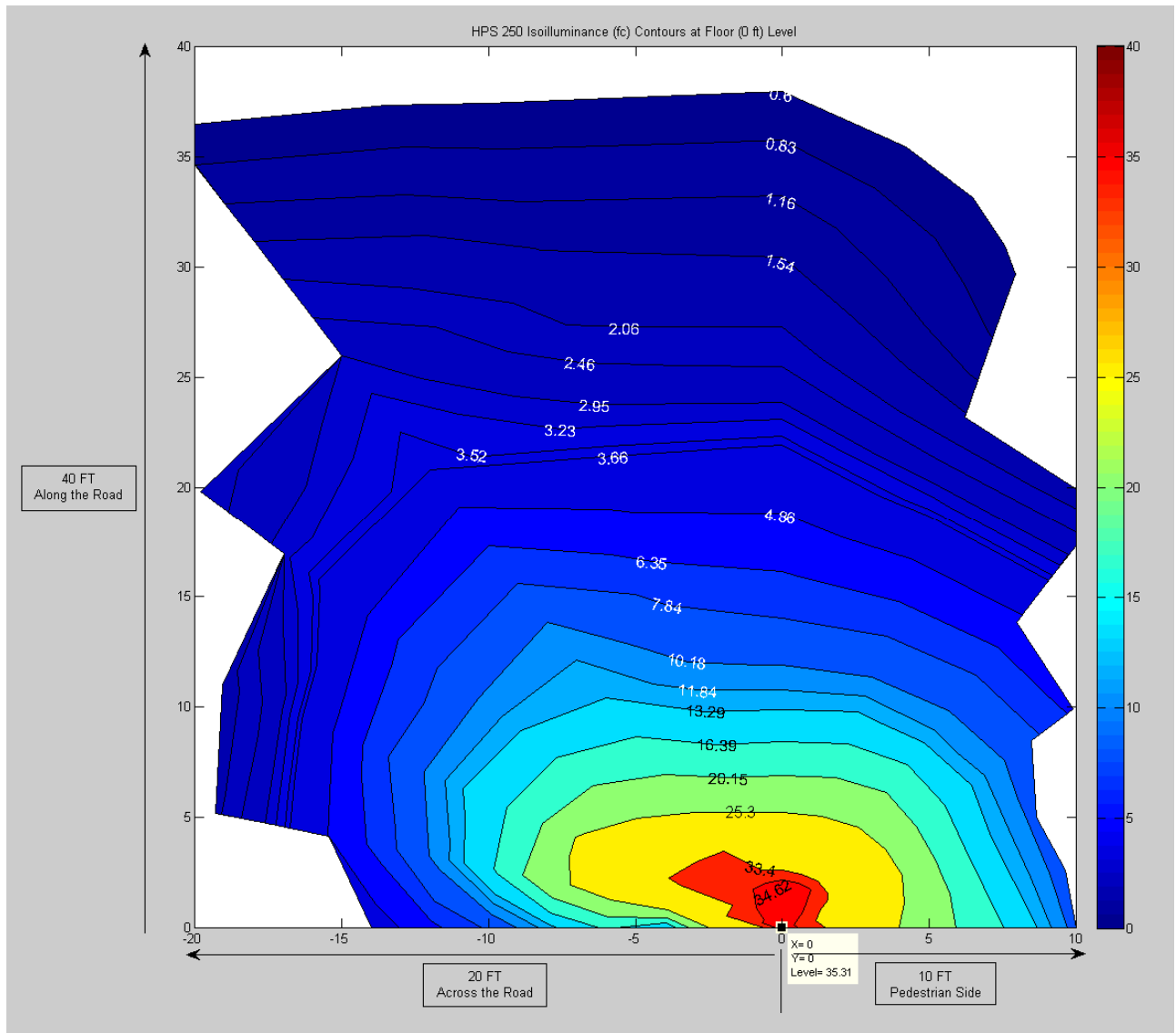

Figure 12: Contour Plot of Isoilluminance (fc) for HPS 250 at the Floor (0 Feet) Level on Measurement Grid

Figures 13-22: Surface Plots of Illuminance (fc) at a) 0, b) 2, c) 4 and d) 6 Feet Heights on Measurement Grid

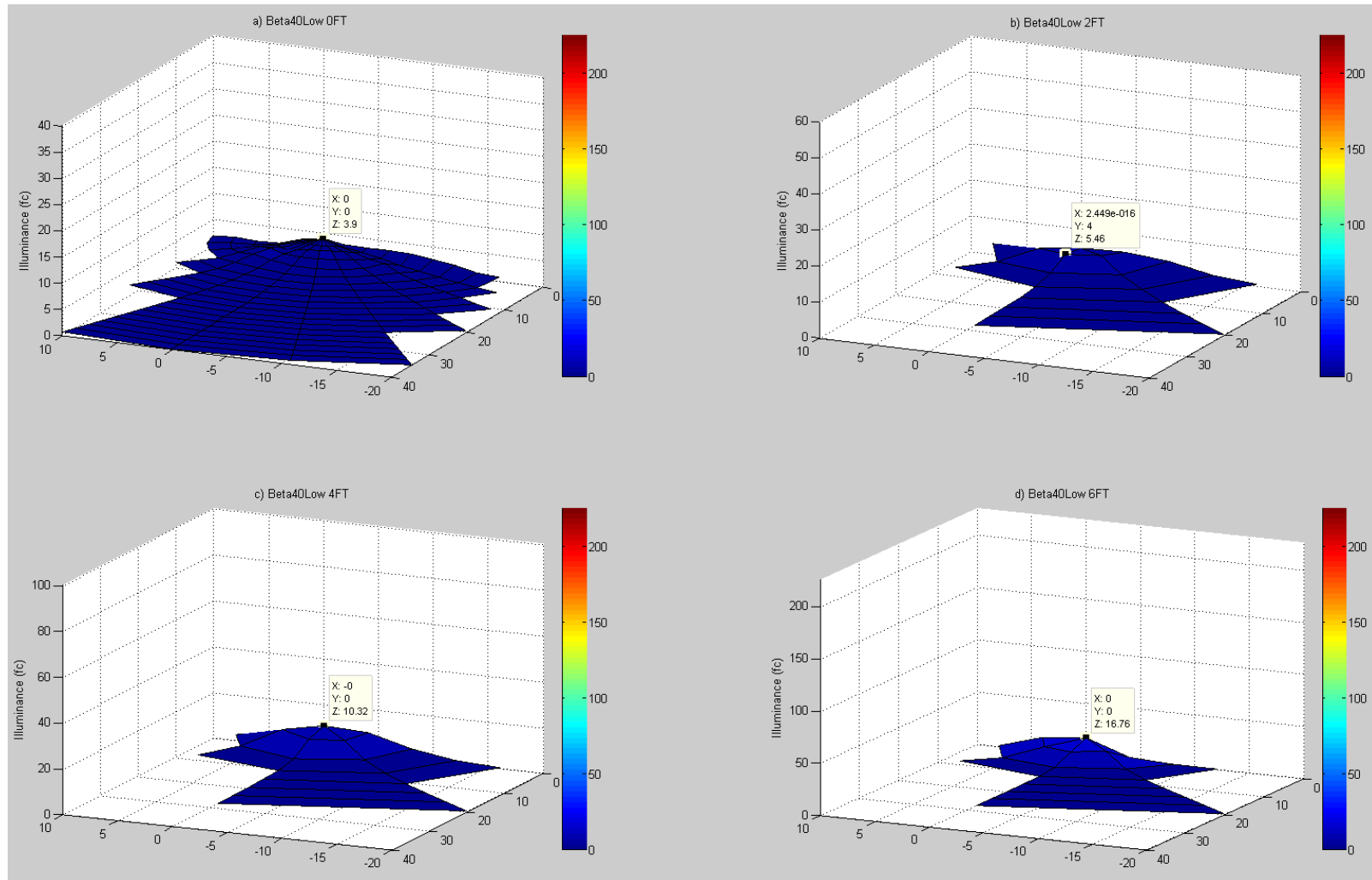

Figure 13: Surface Plots of Illuminance (fc) for Beta 40 LED Low Driver Setting at a) 0, b) 2, c) 4 and d) 6 Feet Heights on Measurement Grid

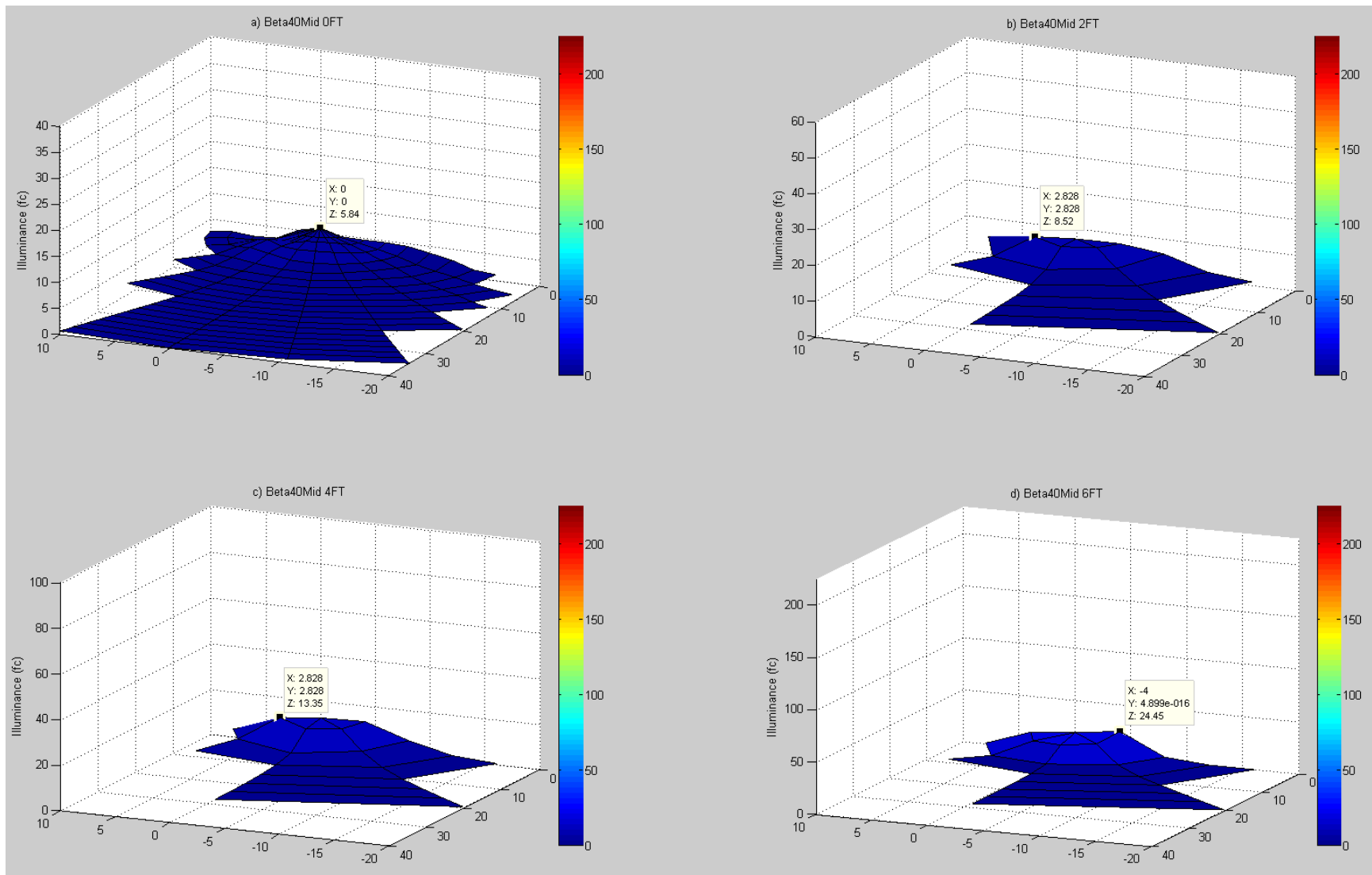

Figure 14: Surface Plots of Illuminance (fc) for Beta 40 LED Mid Driver Setting at a) 0, b) 2, c) 4 and d) 6 Feet Heights on Measurement Grid

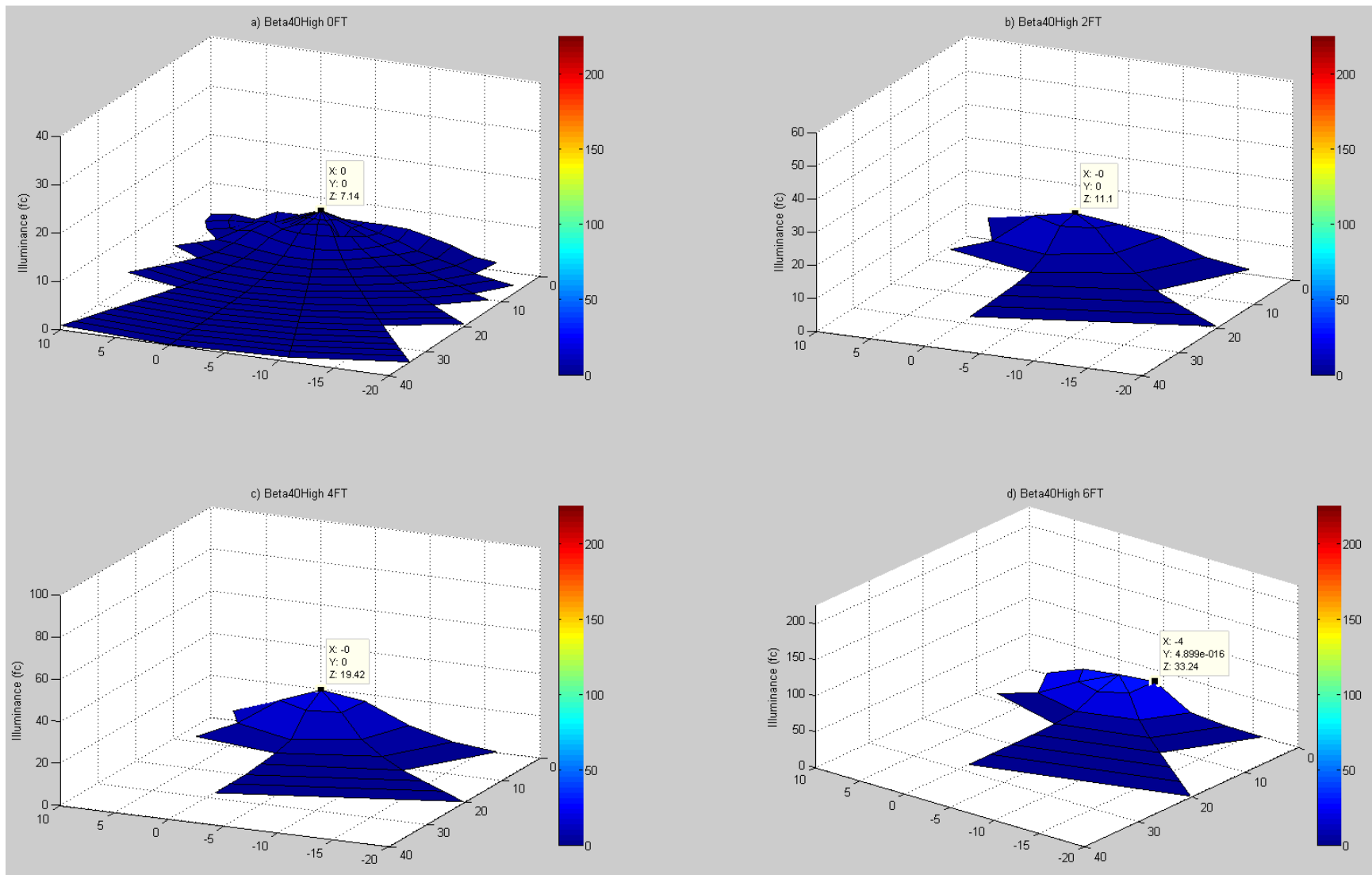

Figure 15: Surface Plots of Illuminance (fc) for Beta 40 LED High Driver Setting at a) 0, b) 2, c) 4 and d) 6 Feet Heights on Measurement Grid

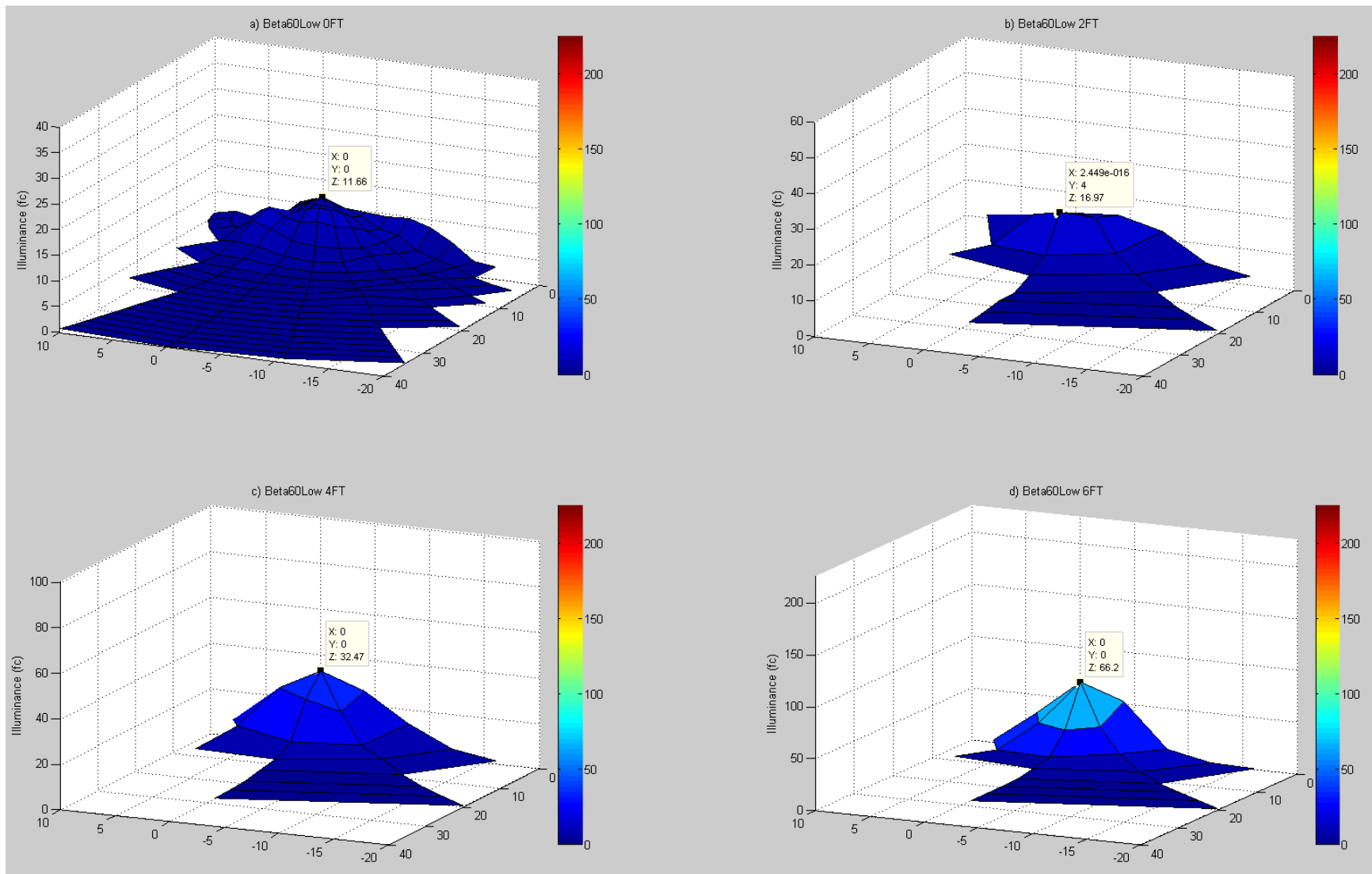

Figure 16: Surface Plots of Illuminance (fc) for Beta 60 LED Low Driver Setting at a) 0, b) 2, c) 4 and d) 6 Feet Heights on Measurement Grid

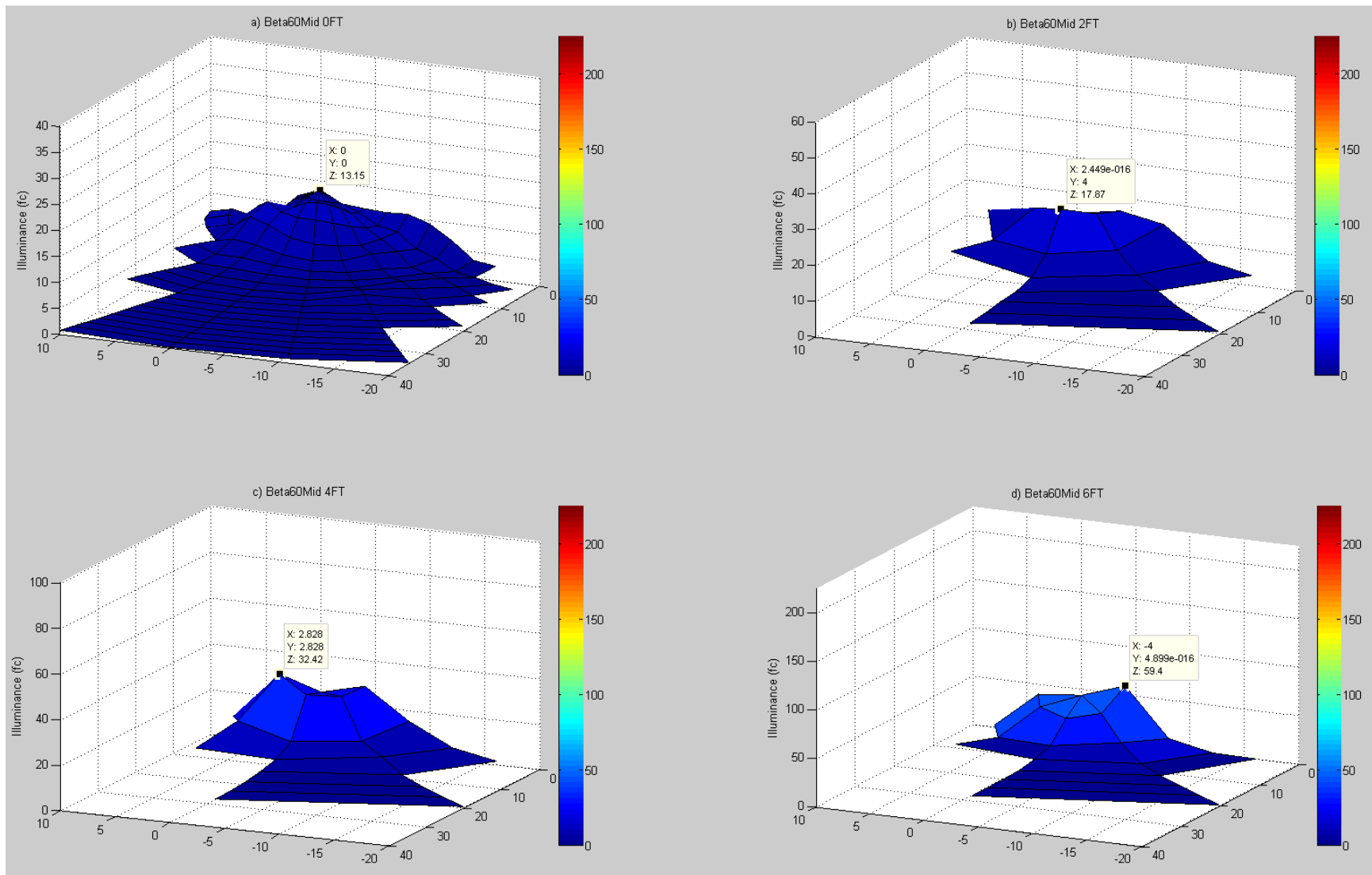

Figure 17: Surface Plots of Illuminance (fc) for Beta 60 LED Mid Driver Setting at a) 0, b) 2, c) 4 and d) 6 Feet Heights on Measurement Grid

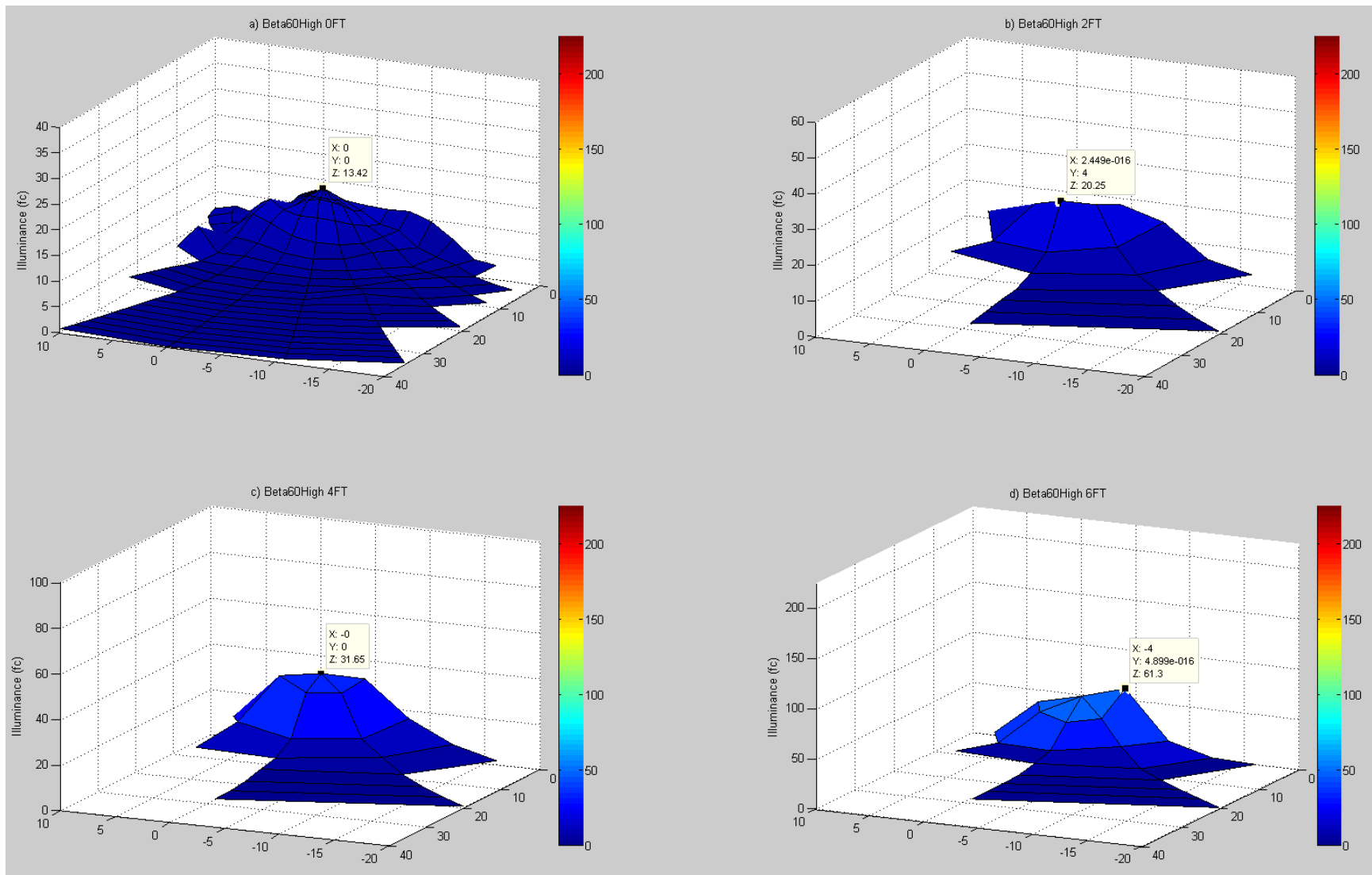

Figure 18: Surface Plots of Illuminance (fc) for Beta 60 LED High Driver Setting at a) 0, b) 2, c) 4 and d) 6 Feet Heights on Measurement Grid

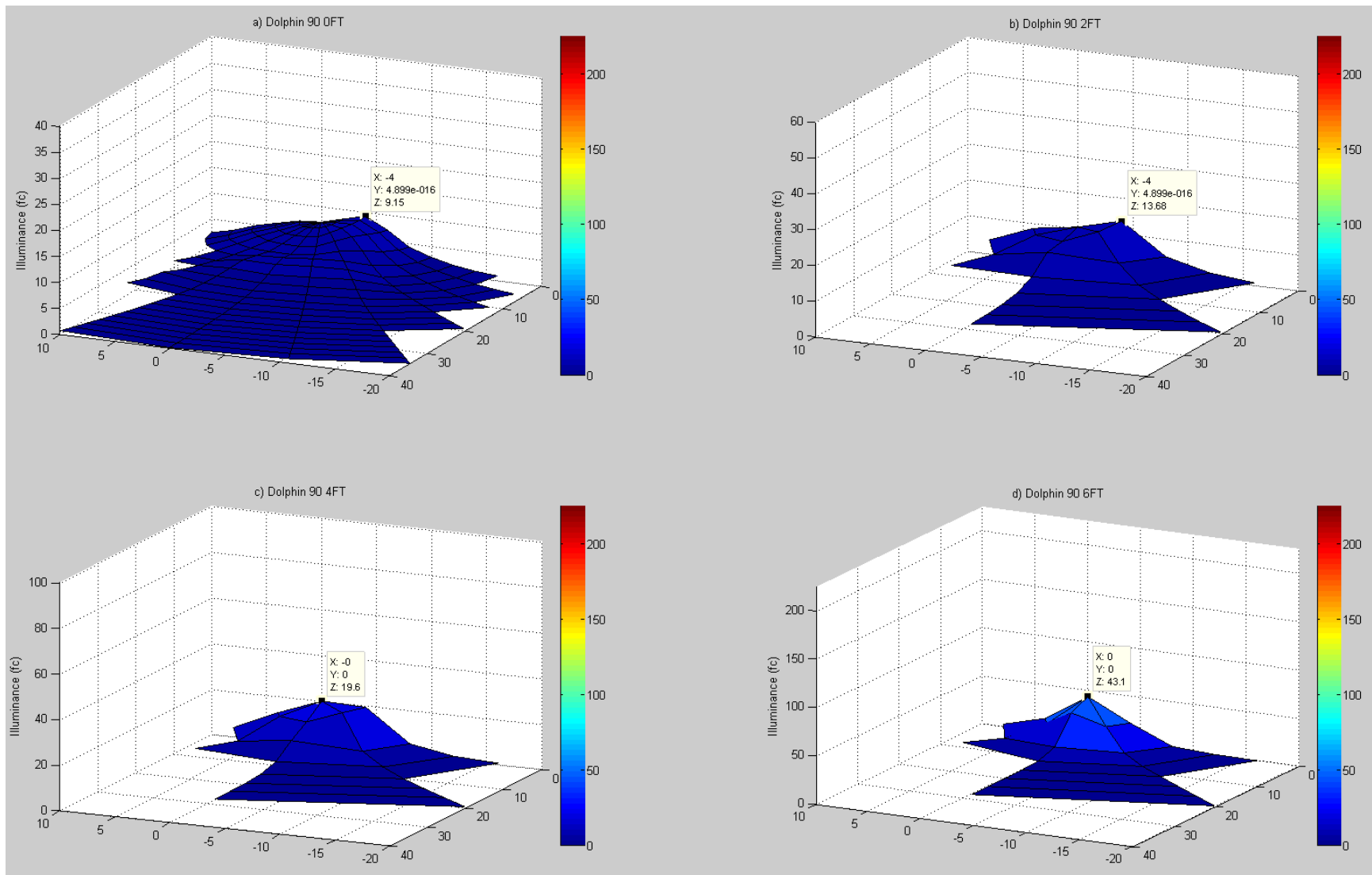

Figure 19: Surface Plots of Illuminance (fc) for Dolphin 90 LED at a) 0, b) 2, c) 4 and d) 6 Feet Heights on Measurement Grid

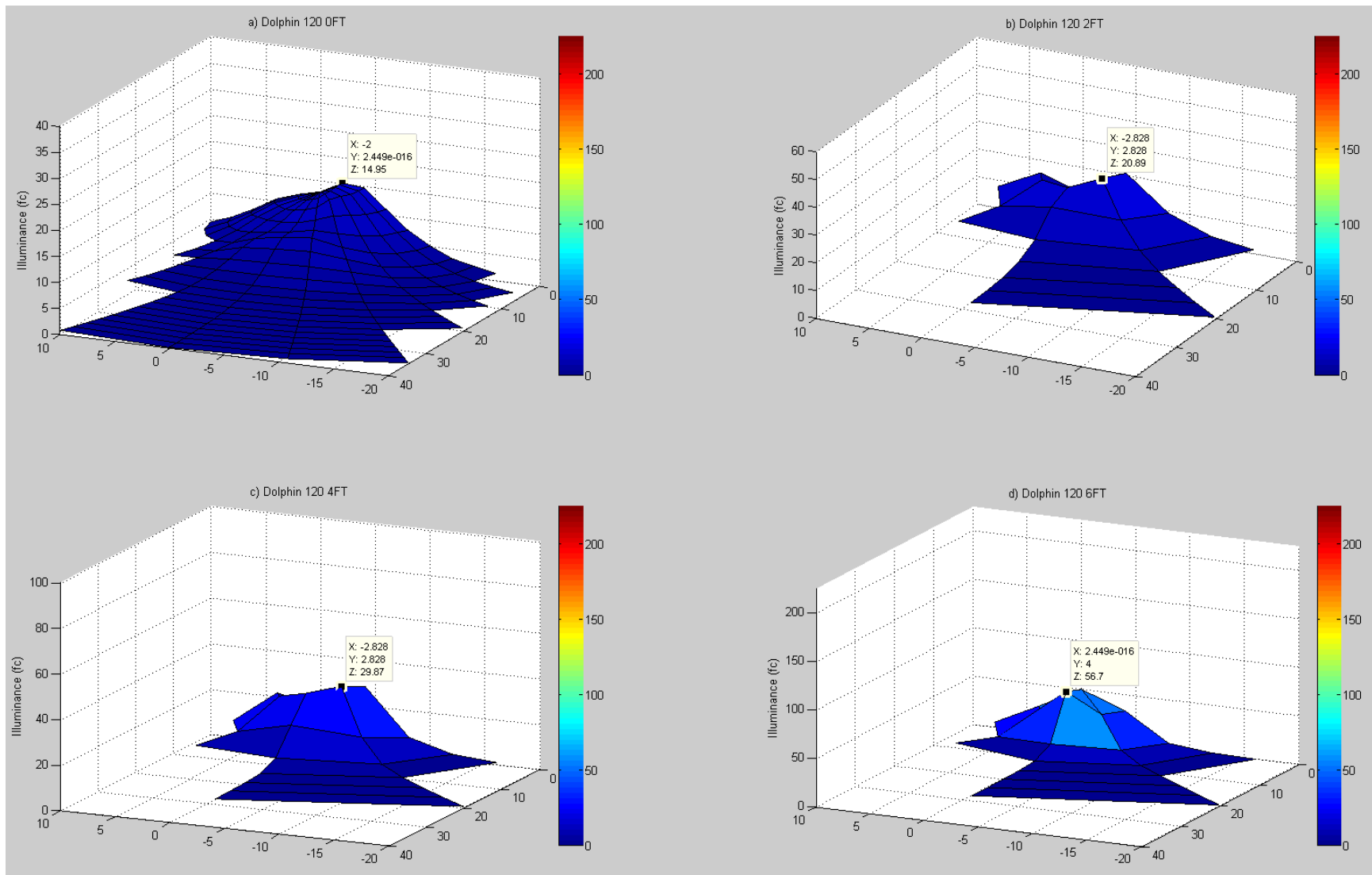

Figure 20: Surface Plots of Illuminance (fc) for Dolphin 120 LED at a) 0, b) 2, c) 4 and d) 6 Feet Heights on Measurement Grid

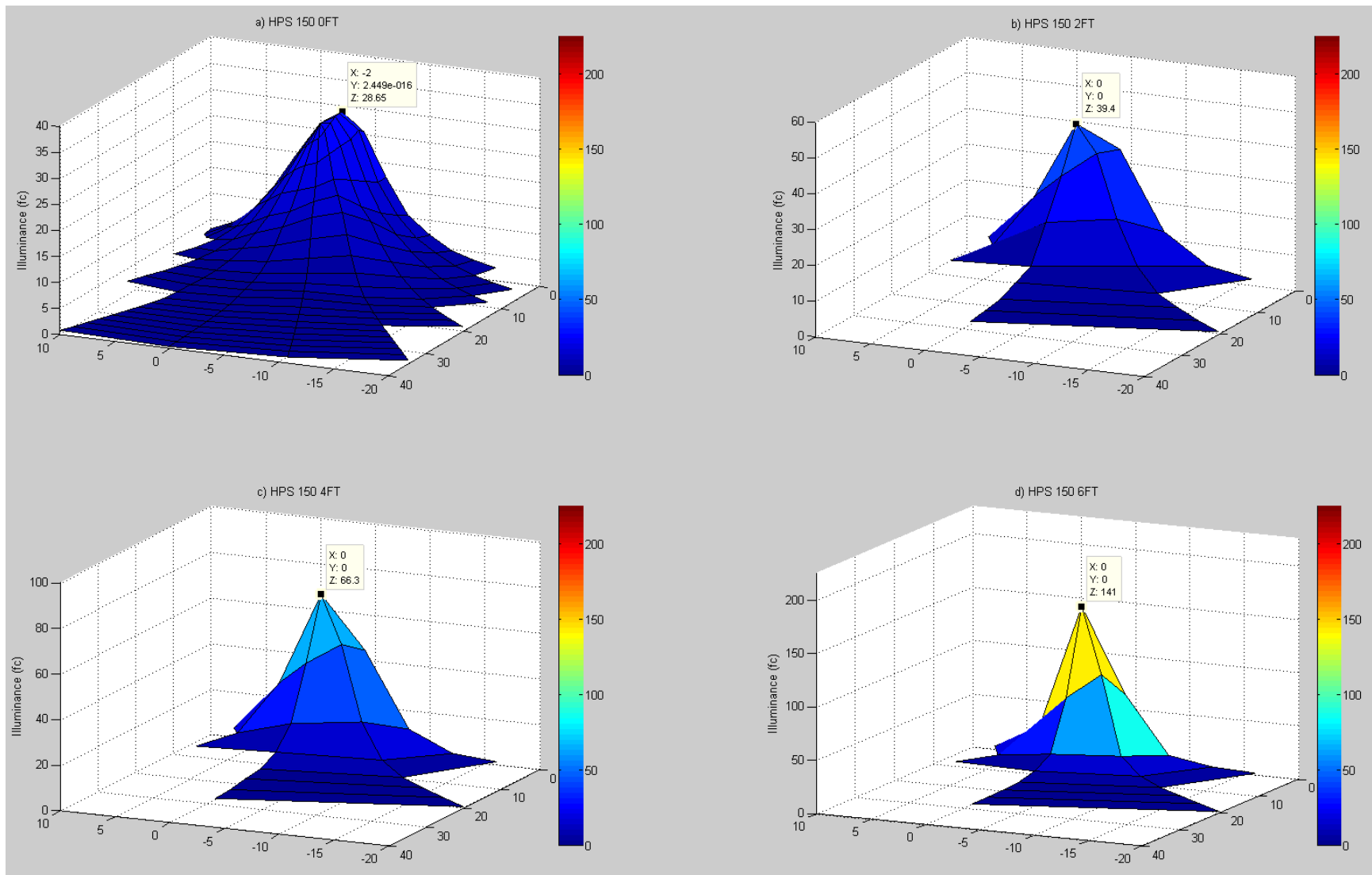

Figure 21: Surface Plots of Illuminance (fc) for HPS 150 at a) 0, b) 2, c) 4 and d) 6 Feet Heights on Measurement Grid

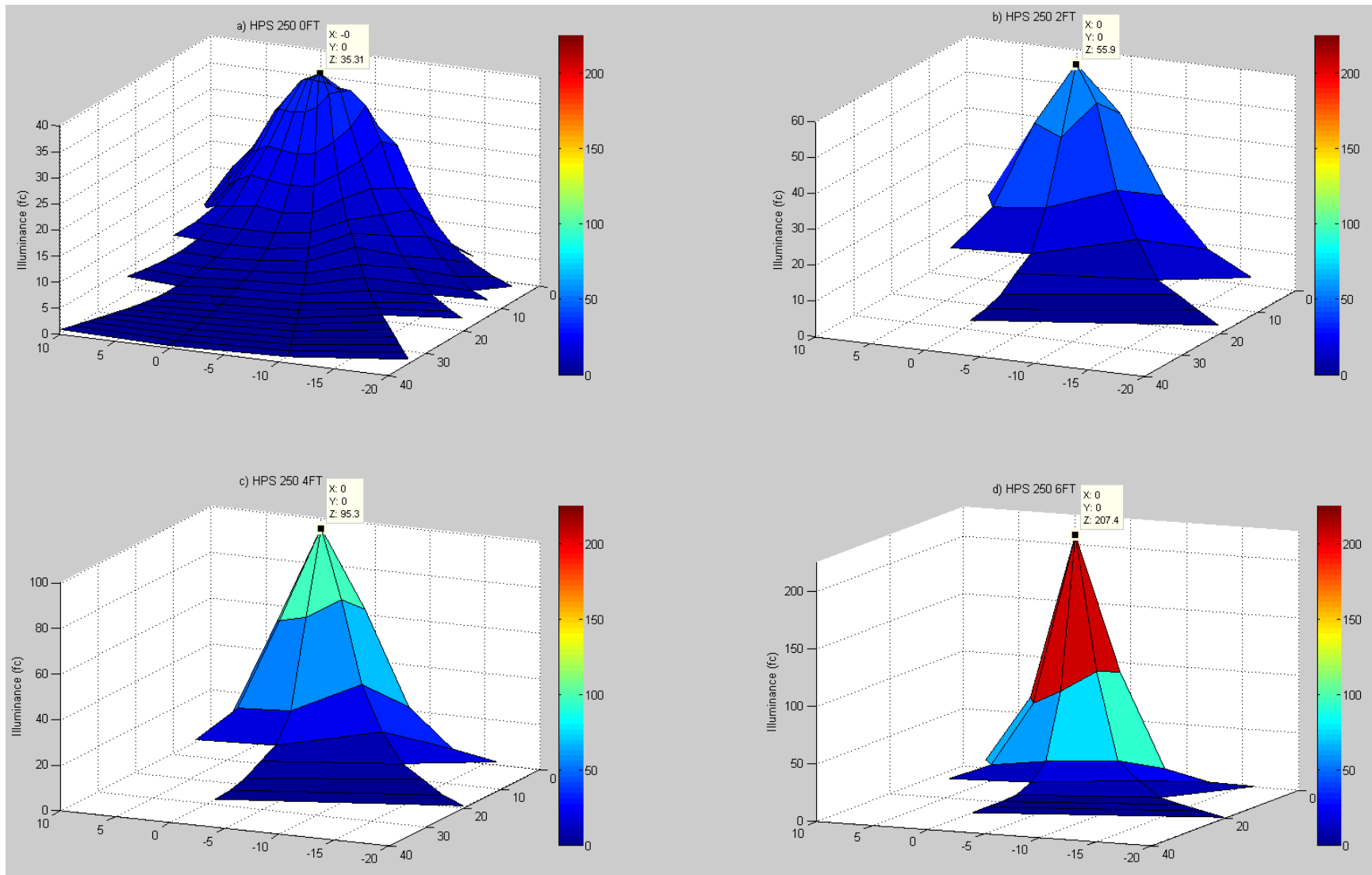

Figure 22: Surface Plots of Illuminance (fc) for HPS 250 at a) 0, b) 2, c) 4 and d) 6 Feet Heights on Measurement Grid

Figures 23-32: Contour Plots of Isoilluminance (fc) at Floor Level on Measurement Grid for a) 20 Feet and b) 30 Feet Mounting Height

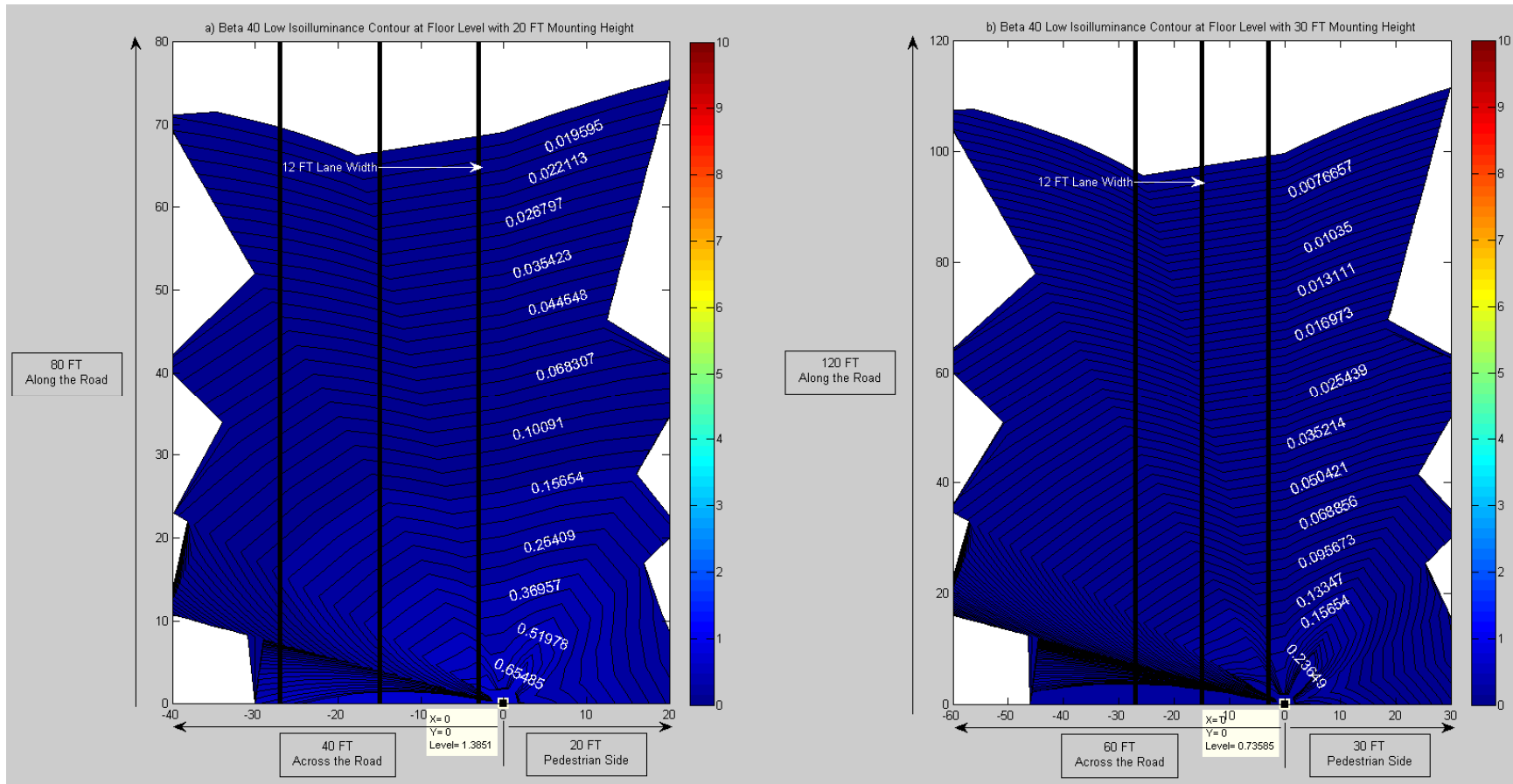

Figure 23: Contour Plots of Isoilluminance (fc) for Beta 40 LED Low Driver Setting at Floor Level (0 feet) on Measurement Grid with Light at a) 20 Feet and b) 30 Feet Height

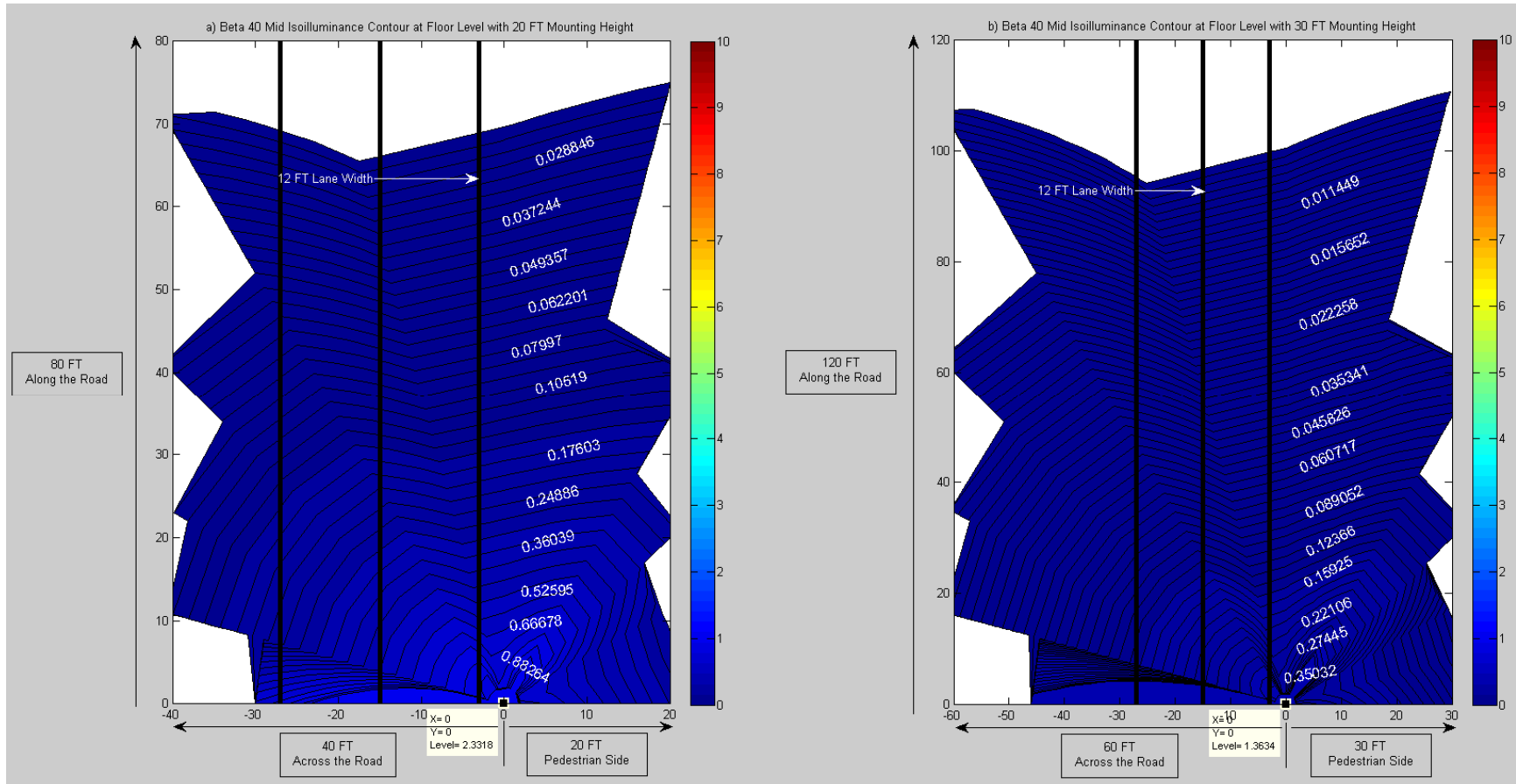

Figure 24: Contour Plots of Isoilluminance (fc) for Beta 40 LED Mid Driver Setting at Floor Level (0 feet) on Measurement Grid with Light at a) 20 Feet and b) 30 Feet Height

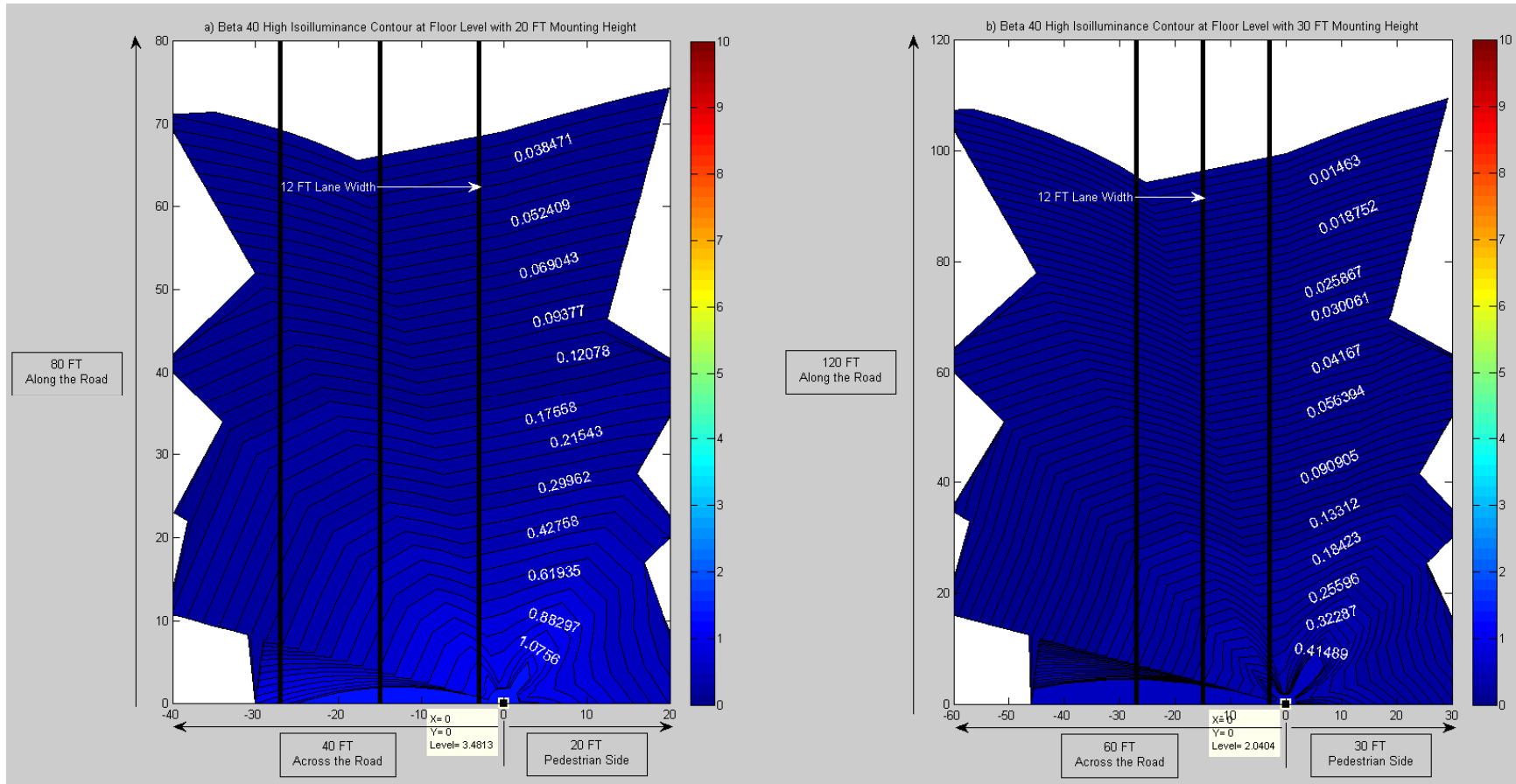

Figure 25: Contour Plots of Isoilluminance (fc) for Beta 40 LED High Driver Setting at Floor Level (0 feet) on Measurement Grid with Light at a) 20 Feet and b) 30 Feet Height

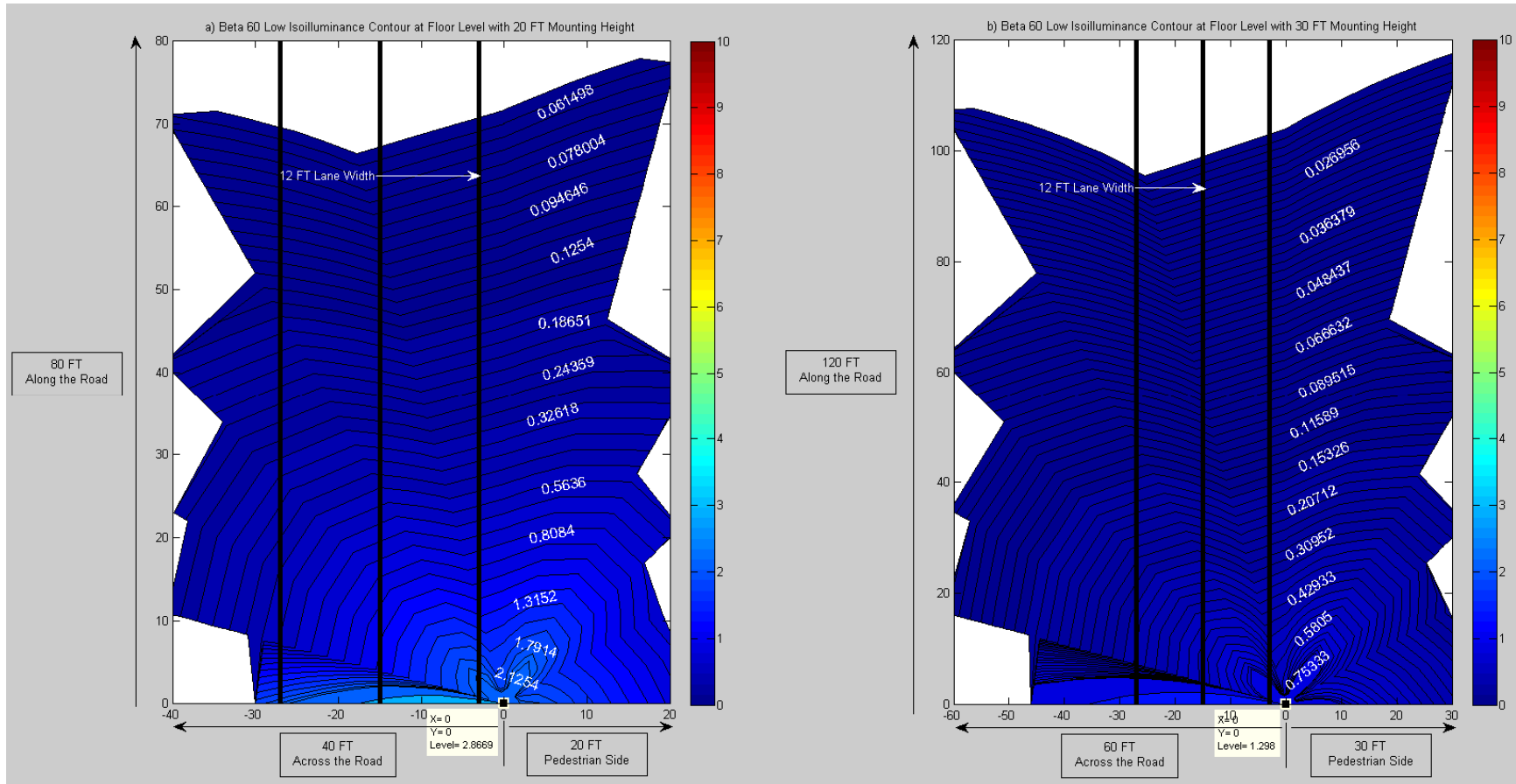

Figure 26: Contour Plots of Isoilluminance (fc) for Beta 60 LED Low Driver Setting at Floor Level (0 feet) on Measurement Grid with Light at a) 20 Feet and b) 30 Feet Height

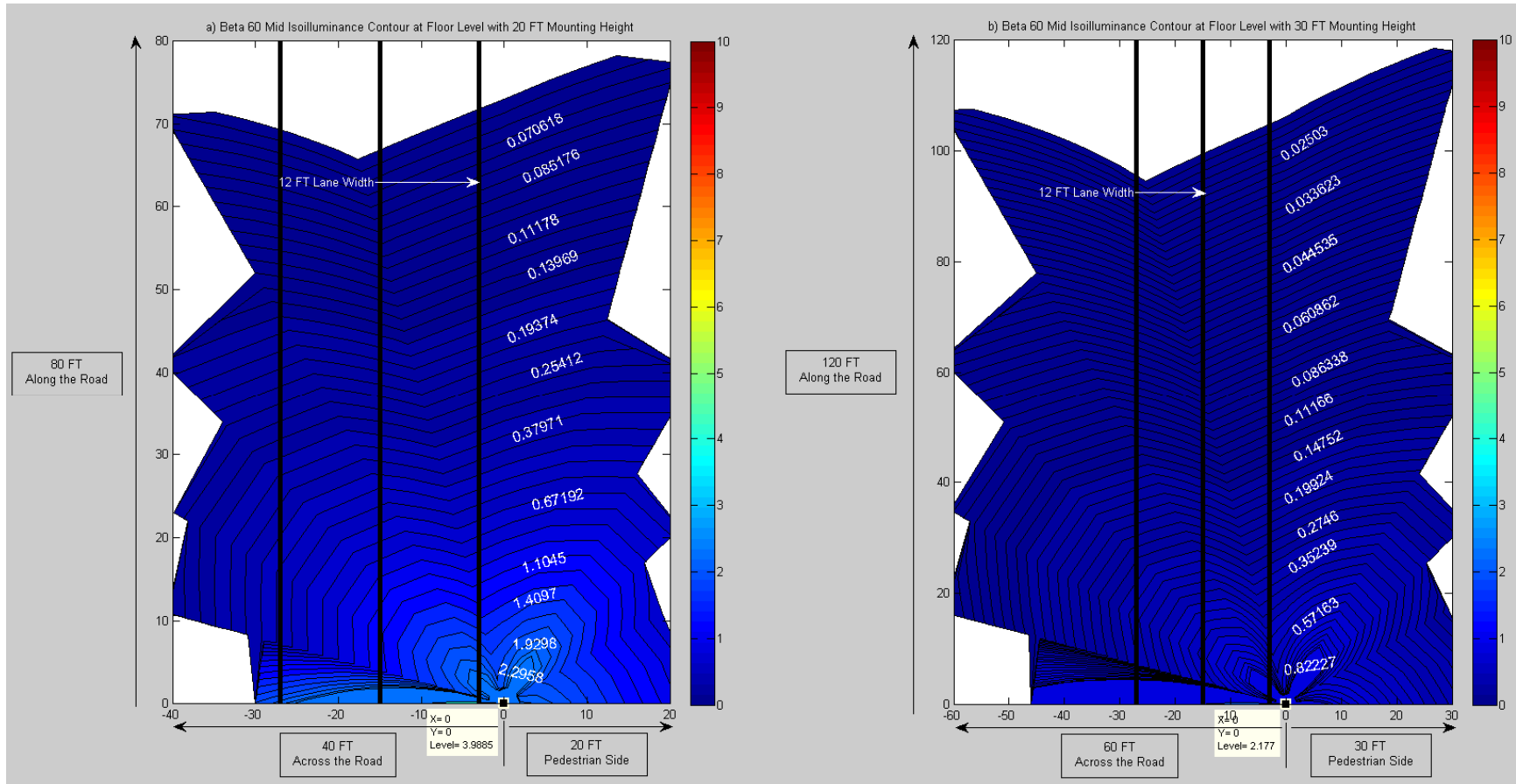

Figure 27: Contour Plots of Isoilluminance (fc) for Beta 60 LED Mid Driver Setting at Floor Level (0 feet) on Measurement Grid with Light at a) 20 Feet and b) 30 Feet Height

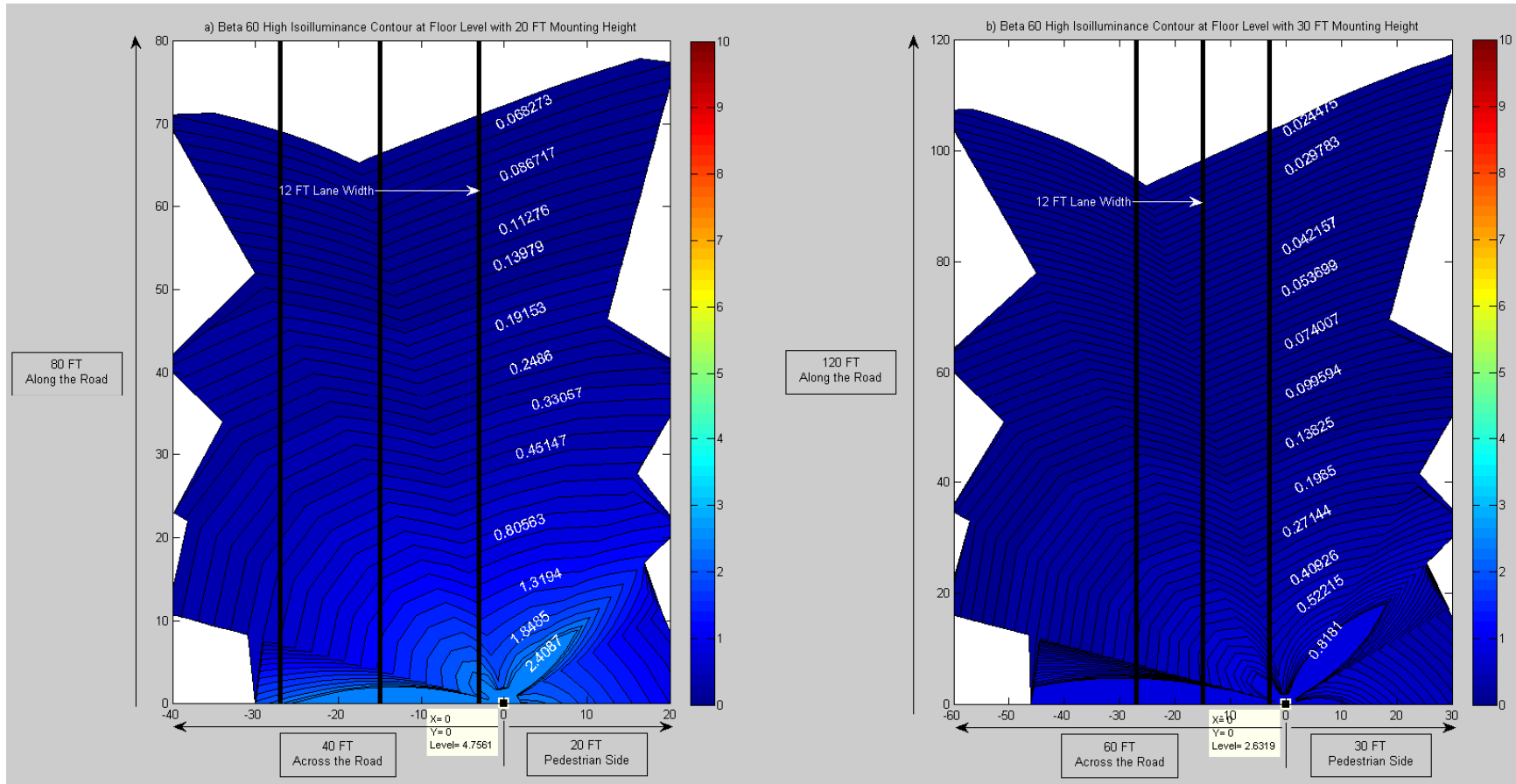

Figure 28: Contour Plots of Isoilluminance (fc) for Beta 60 LED High Driver Setting at Floor Level (0 feet) on Measurement Grid with Light at a) 20 Feet and b) 30 Feet Height

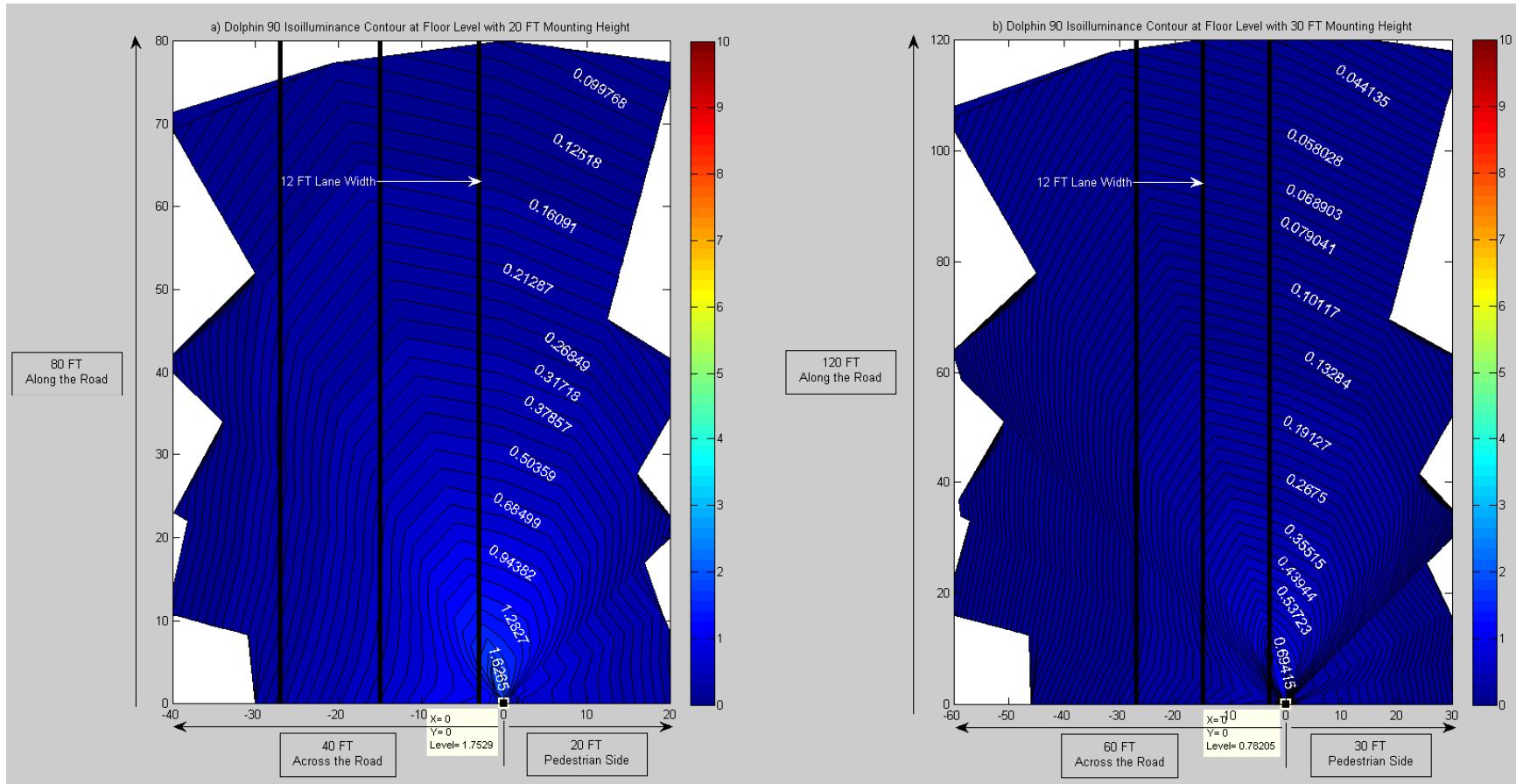

Figure 29: Contour Plots of Isoilluminance (fc) for Dolphin 90 LED at Floor Level (0 feet) on Measurement Grid with Light at a) 20 Feet and b) 30 Feet Height

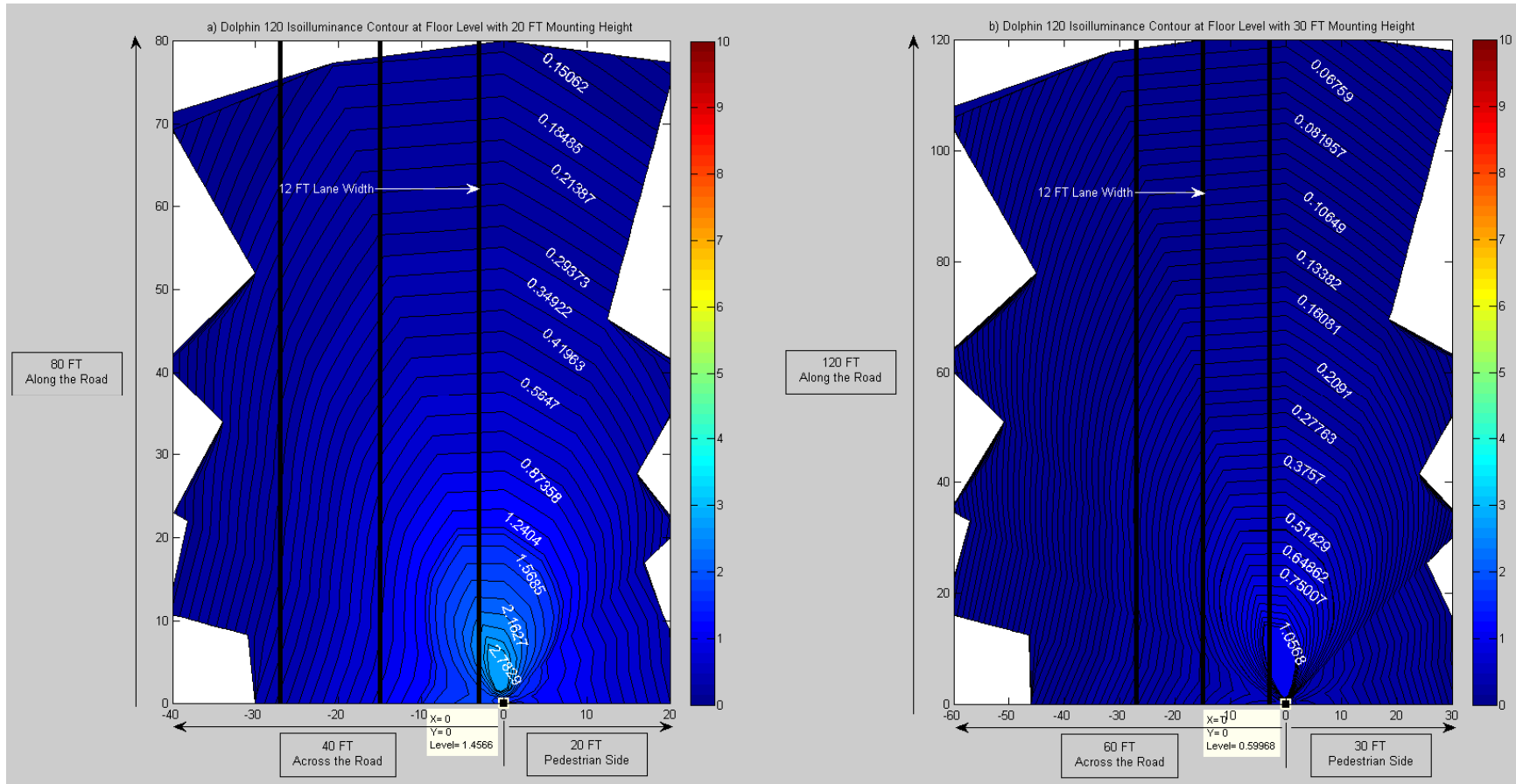

Figure 30: Contour Plots of Isoilluminance (fc) for Dolphin 120 LED at Floor Level (0 feet) on Measurement Grid with Light at a) 20 Feet and b) 30 Feet Height

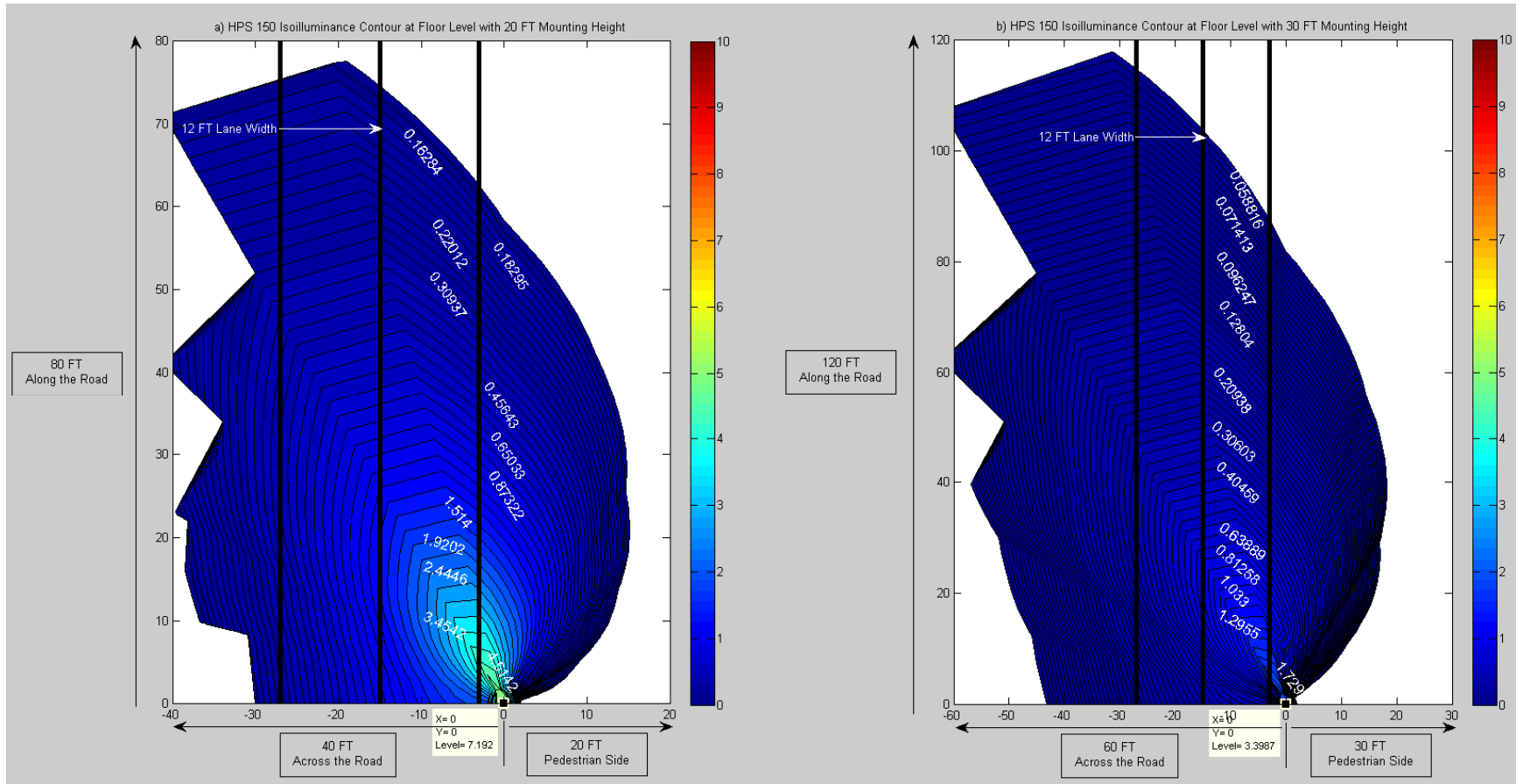

Figure 31: Contour Plots of Isoilluminance (fc) for HPS 150 at Floor Level (0 feet) on Measurement Grid with Light at a) 20 Feet and b) 30 Feet Height

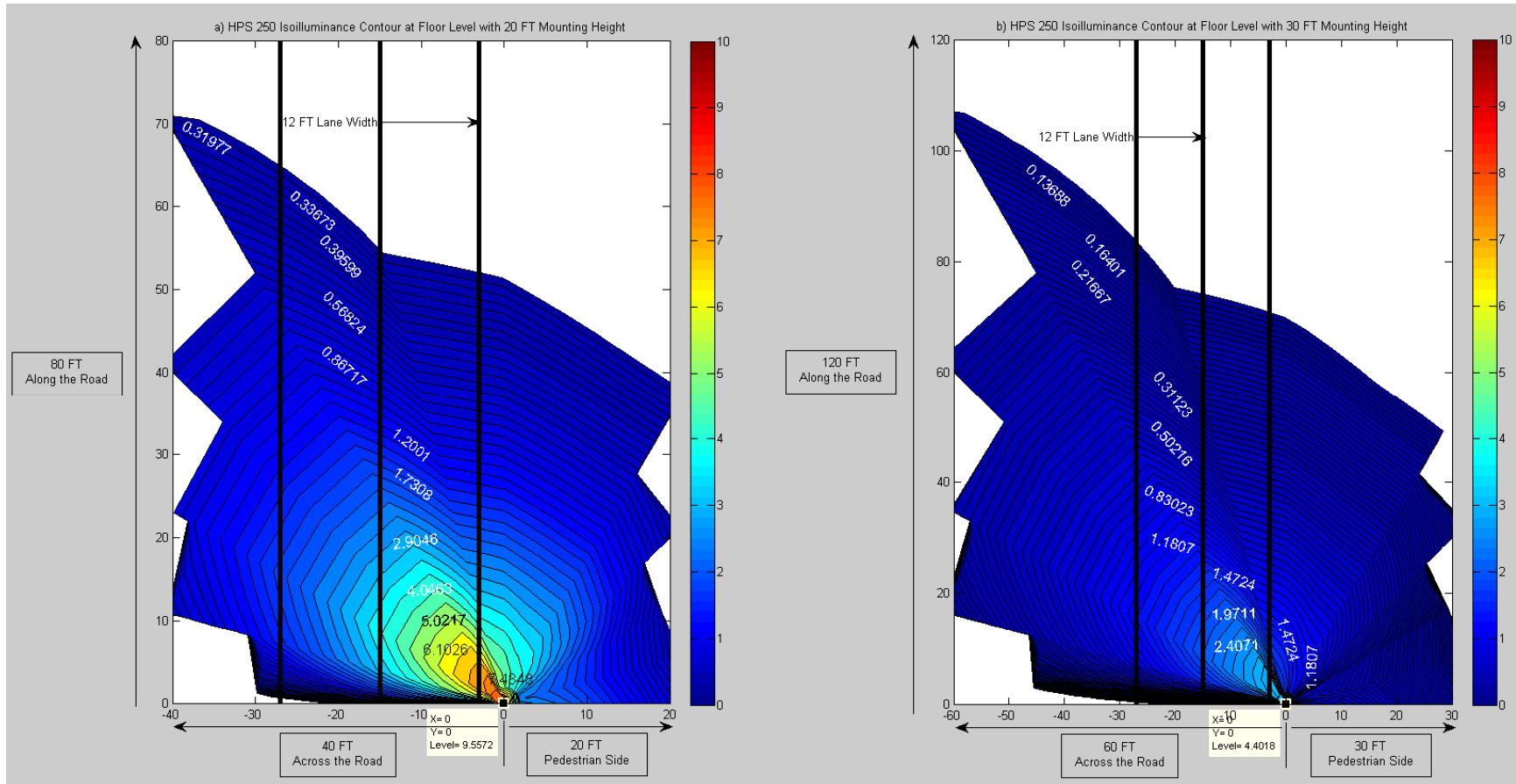

Figure 32: Contour Plots of Isoilluminance (fc) for HPS 250 at Floor Level (0 feet) on Measurement Grid with Light at a) 20 Feet and b) 30 Feet Height

APPENDIX D: Figures 33-39: Light Spectrum at a) 0 and b) 6 Feet Heights at the Center of Light

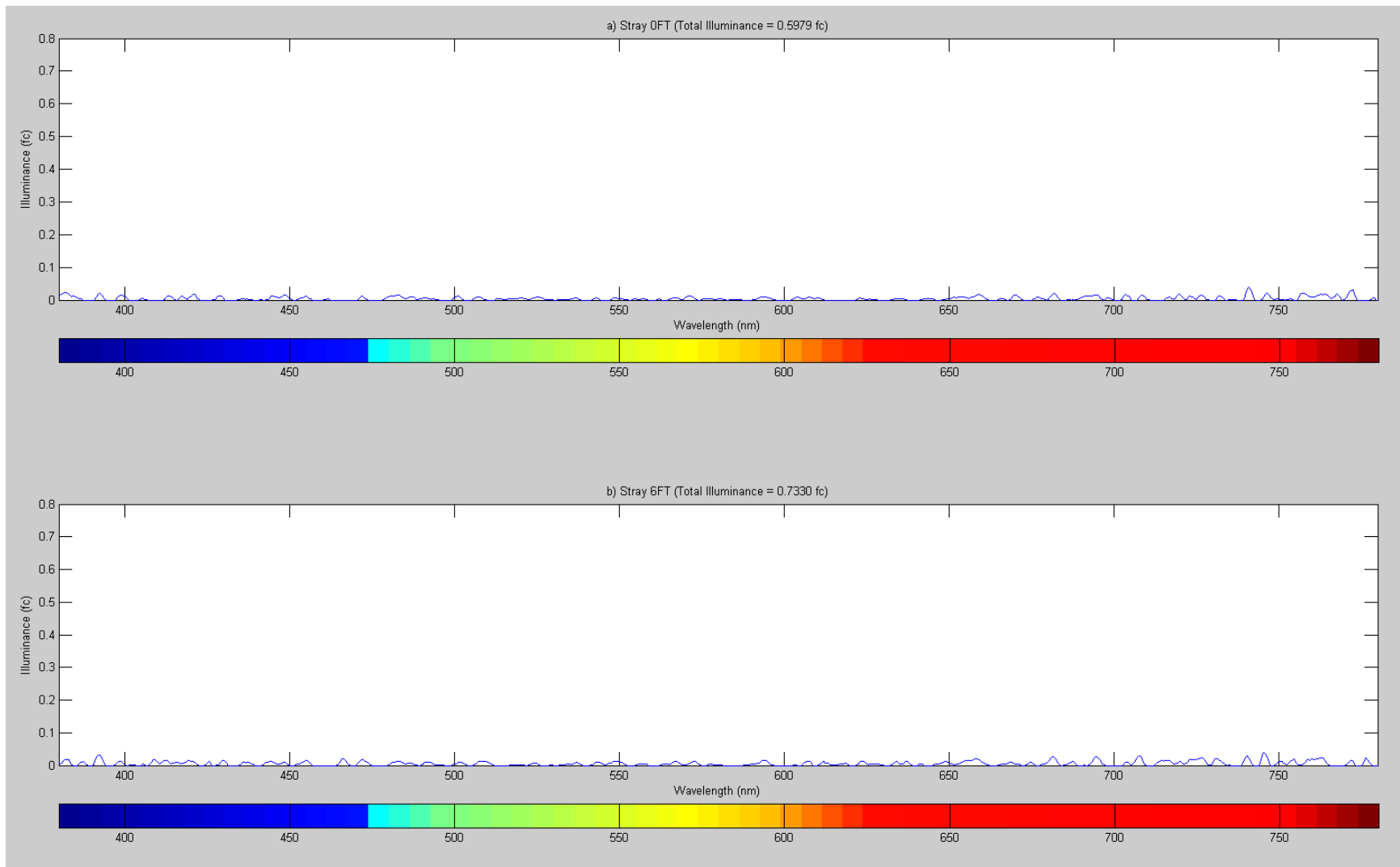

Figure 33: Stray Light Spectrum at a) 0 and b) 6 Feet Heights at the Center of Light

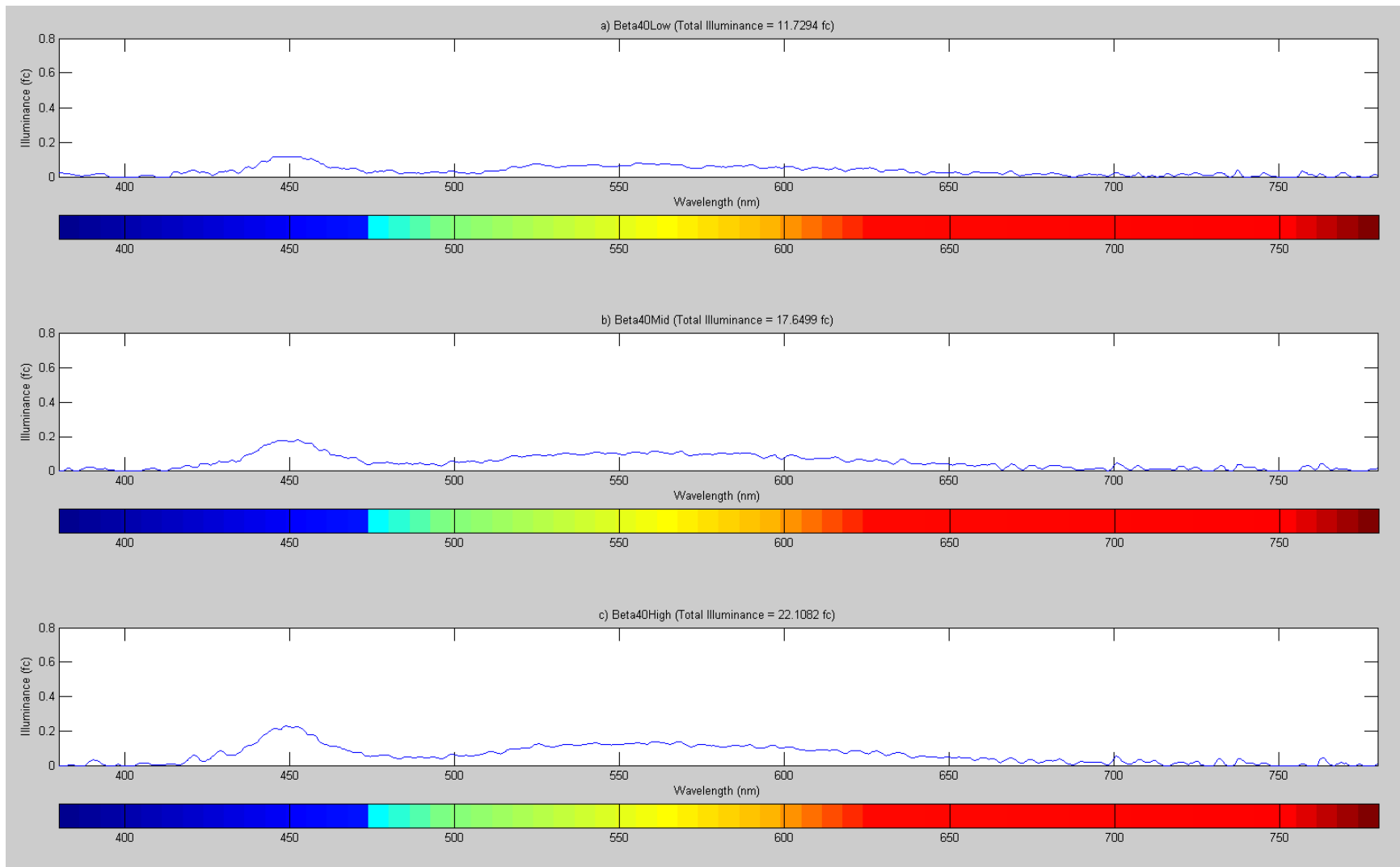

Figure 34: Light Spectrum for Beta 40 LED on a) Low, b) Medium, and c) High Driver Setting at 6 Feet Height at the Center of Light

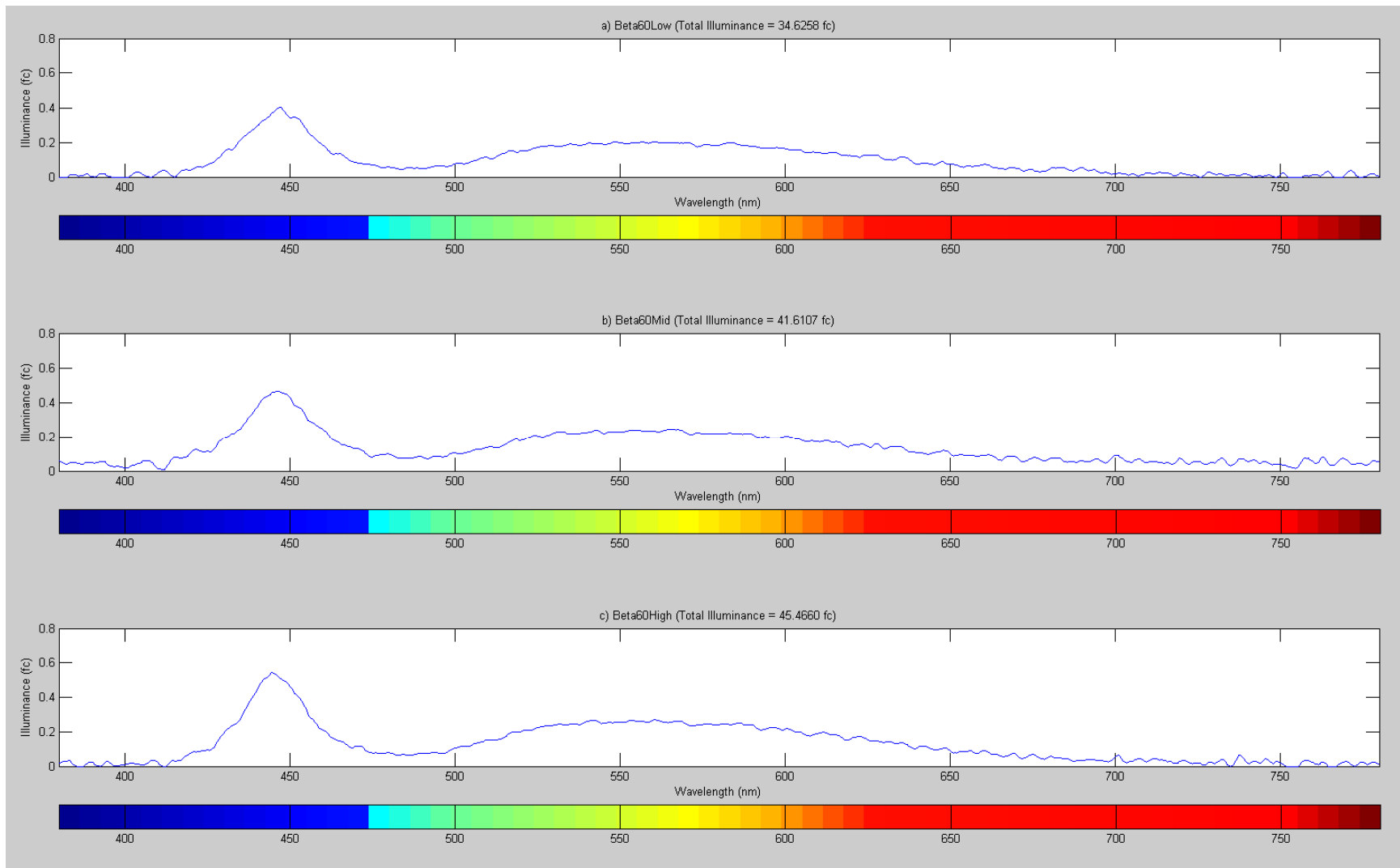

Figure 35: Light Spectrum for Beta 60 LED on a) Low, b) Medium, and c) High Driver Setting at 6 Feet Height at the Center of Light

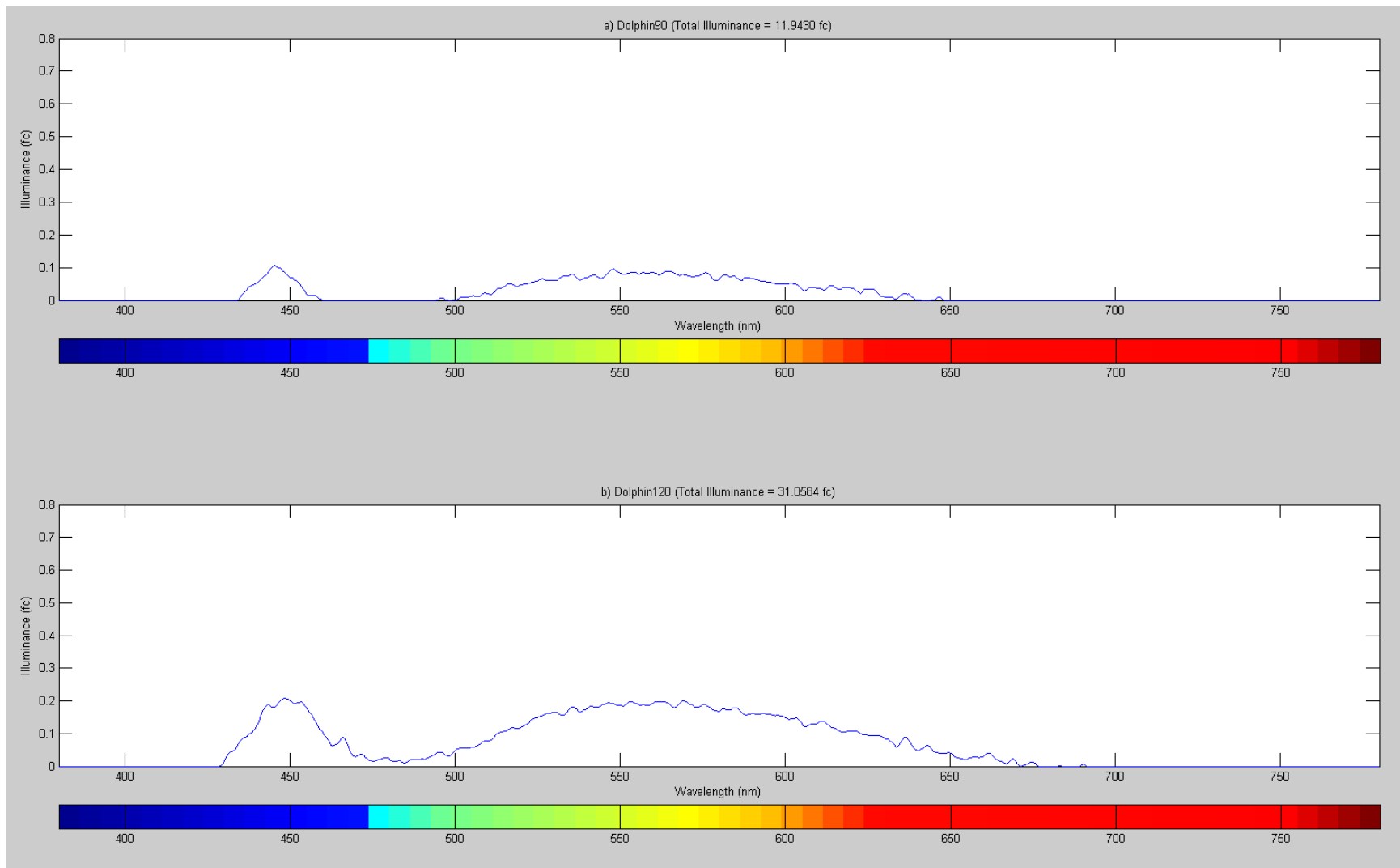

Figure 36: Light Spectrum for a) Dolphin 90 and b) Dolphin 120 at 6 Feet Height at the Center of Light

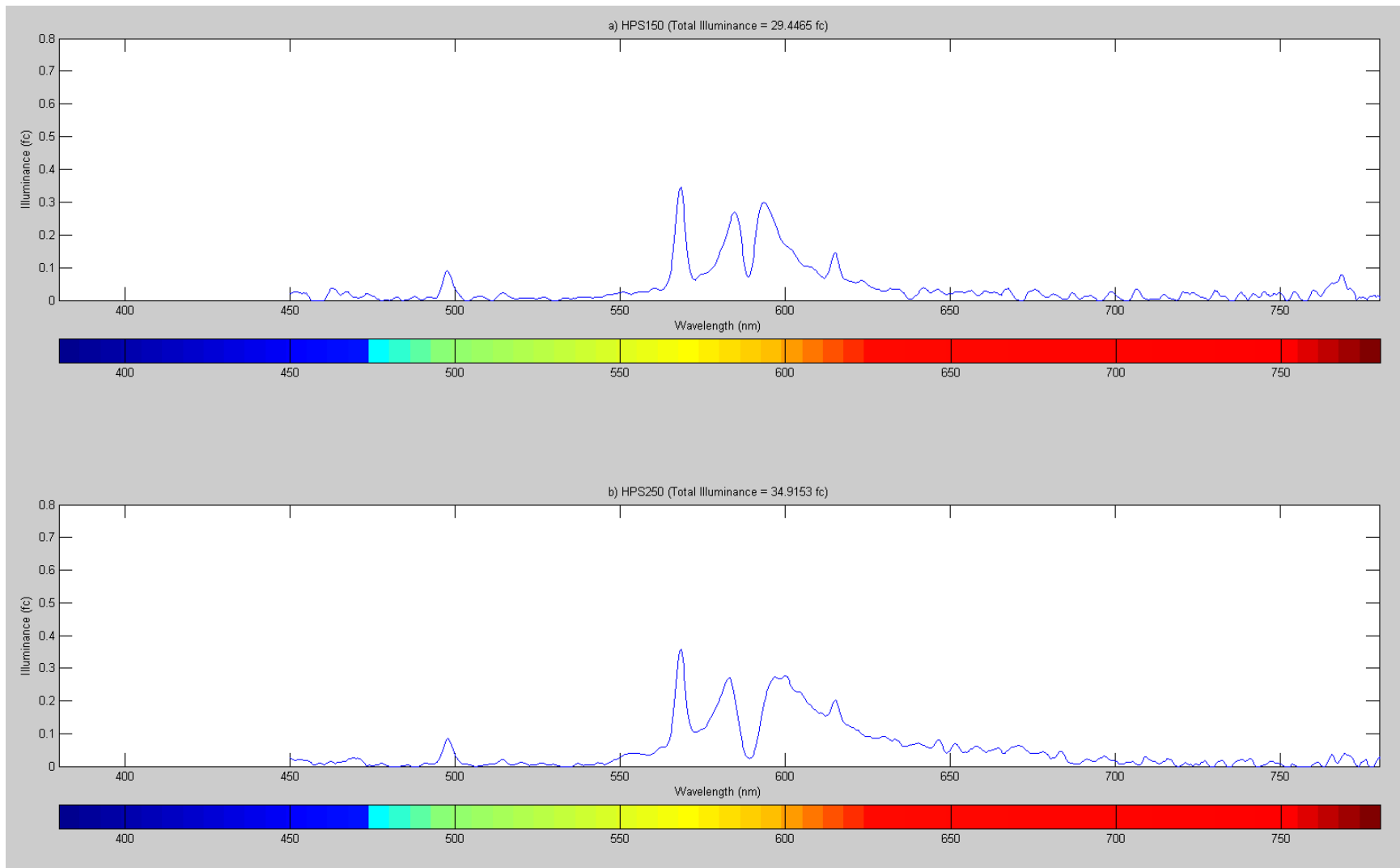

Figure 37: Light Spectrum for a) HPS 150 and b) HPS 250 at Floor Level (0 Feet) at the Center of Light

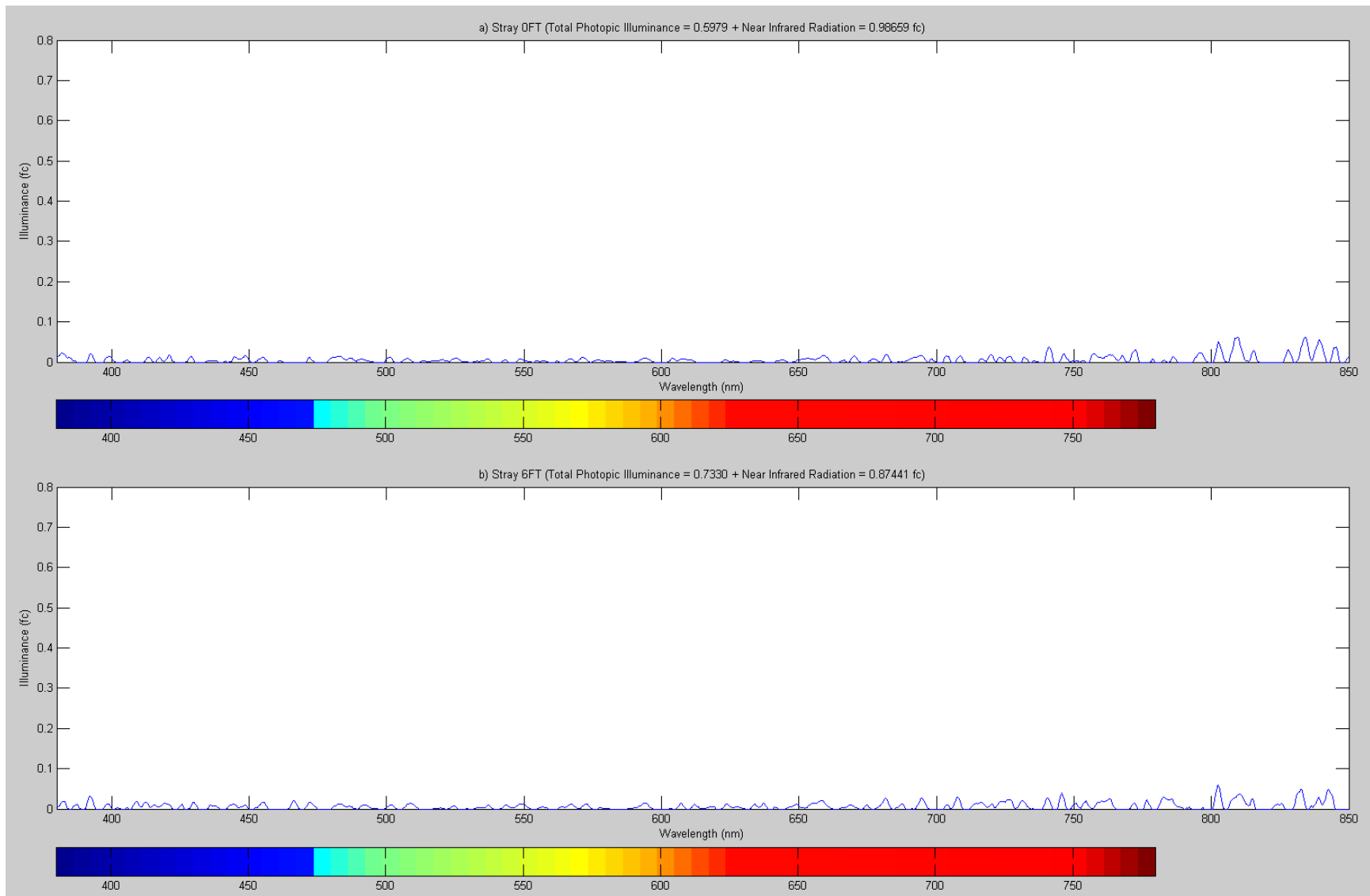

Figure 38: Stray Light Spectrum (including near Infrared) at Floor Level (0 Feet) at the Center of Light

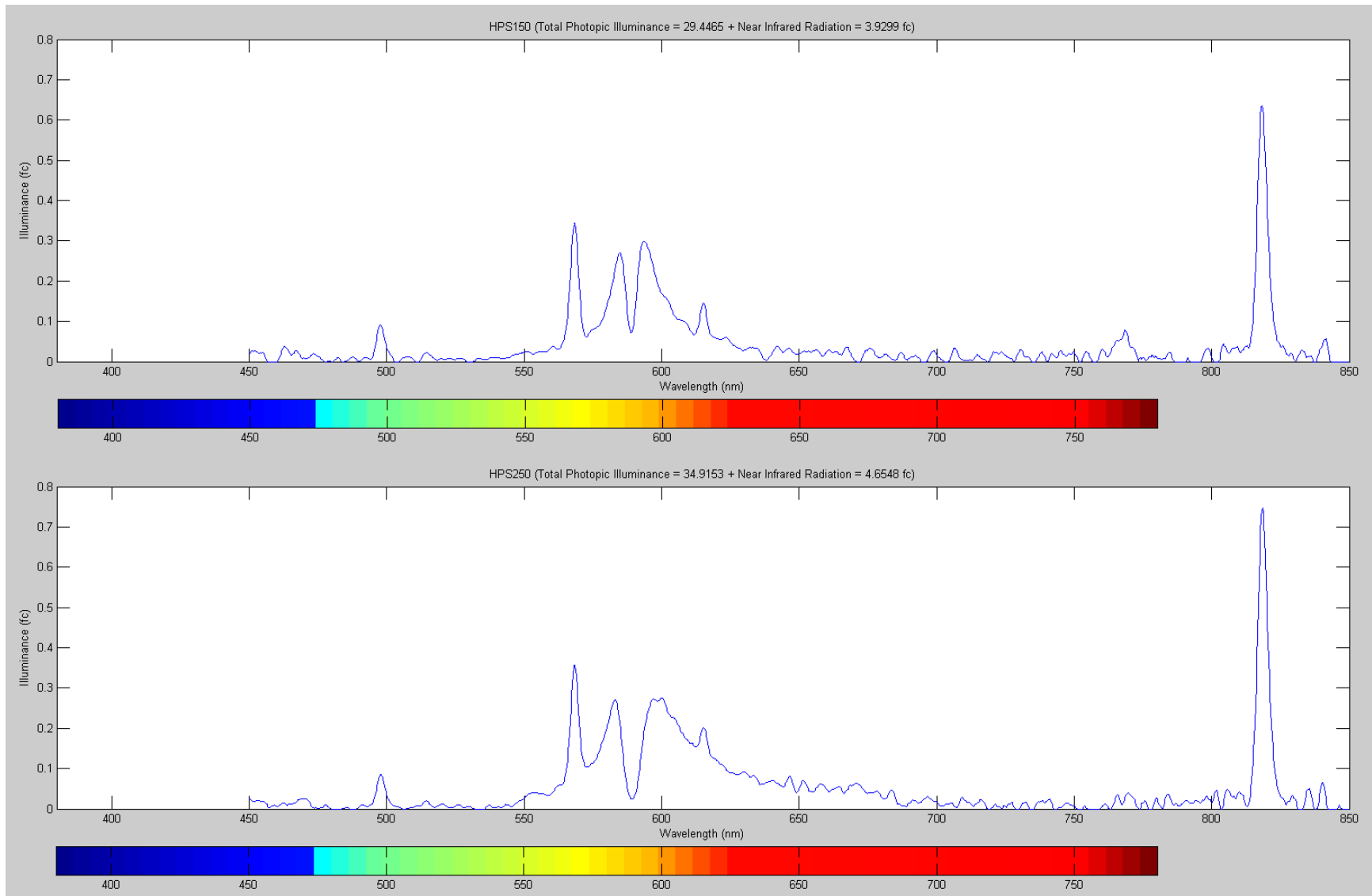

Figure 39: Light Spectrum (including near Infrared) for a) HPS 150 and b) HPS 250 at Floor Level (0 Feet) at the Center of Light

